

BeoLab 5

WARNING: To reduce the risk of fire or electric shock, do not expose this appliance to rain or moisture. Do not expose this equipment to dripping or splashing and ensure that no objects filled with liquids, such as vases, are placed on the equipment.

The product can only be switched off completely by disconnecting it from the mains socket. The mains socket must always be accessible.



The lightning flash with arrowhead symbol within an equilateral triangle, is intended to alert the user to the presence of uninsulated "dangerous voltage" within the product's enclosure that may be of sufficient magnitude to constitute a risk of electric shock to persons.



The exclamation point within an equilateral triangle is intended to alert the user to the presence of important operating and maintenance (servicing) instructions in the literature accompanying the product.



This product is in conformity with the provisions of the Directives 2004/108/EC and 2006/95/EC.

Read these instructions.

Keep these instructions.

Heed all warnings.

Follow all instructions.

Do not use this apparatus near water.

Clean only with dry cloth.

Do not block any ventilation openings. Install in accordance with the manufacturer's instructions.

Do not install near any heat sources such as radiators, heat registers, stoves, or other apparatus (including amplifiers) that produce heat.

Do not defeat the safety purpose of the polarized or grounding-type plug. A polarized plug has two blades with one wider than the other. A grounding type plug has two blades and a third grounding prong. The wide blade or the third prong are provided for your safety. If the provided plug does not fit into your outlet, consult an electrician for replacement of the obsolete outlet.

Protect the power cord from being walked on or pinched particularly at plugs, convenience receptacles, and the point where they exit from the apparatus.

Only use attachments/accessories specified by the manufacturer.



Use only with the cart, stand, tripod, bracket, or table specified by the manufacturer, or sold with the apparatus. When a cart is used, use caution when moving the cart/apparatus combination to avoid injury from tip-over.

Unplug this apparatus during lightning storms or when unused for long periods of time.

Refer all servicing to qualified service personnel. Servicing is required when the apparatus has been damaged in any way, such as power-supply cord or plug is damaged, liquid has been spilled or objects have fallen into the apparatus, the apparatus has been exposed to rain or moisture, does not operate normally, or has been dropped.

The mains plug of the power supply cord shall remain readily operable. Do not expose batteries or battery packs to excessive heat such as sunshine, fire or the like.

Follow instructions to ensure correct and safe installation and interconnection of equipment in multimedia systems.

This Guide describes how to set up a pair of BeoLab 5 loudspeakers and prepare them for use. The Guide provides useful information when you set up the loudspeakers for the first time, and later, if you have to move or rearrange your setup.

For a description of the Beo4 remote control (optional accessory), please refer to its own guide – or to the Guides for your Bang & Olufsen audio or video system.

Follow the instructions in this Guide carefully. Visit our website at:

www.bang-olufsen.com

Daily use, 4

Find information about how to use BeoLab 5, about the built-in loudspeaker protection system, and how to clean BeoLab 5.

Set up BeoLab 5, 6

Important information to consider before setting up BeoLab 5.

Connect cables, 8

Find information about the sockets, and how to connect BeoLab 5 to your audio or video system.

Adapt BeoLab 5 to your system, 11

Find out how to select an Option setting suitable to your particular setup, and how to change the LINE input level setting.

Adapt BeoLab 5 to your room, 12

Read about the unique Adaptive Bass Control system, and how to calibrate BeoLab 5 to your particular room.

Use the PIN code system, 14

Find out about the PIN code system.

Indicator lights and sound signals, 17

An overview of the indicator lights and the sound signals.

Index, 18

Find the specific subject you want to know more about.

Daily use

When you have finished setting up the loudspeaker as described on the following pages, connect the entire audio or video system to the mains.

The loudspeaker is designed to be left in standby when not in use – so do not switch off the power

The *Adaptive Bass Control* system ensures that the bass level suits the placement of the loudspeaker. Therefore, if you move the loudspeaker to a new position, you must perform a new calibration, as explained in *Adapt BeoLab 5 to your room* (pp. 12–13).

Switching on and off

When you switch on your Bang & Olufsen system, the loudspeaker switches on simultaneously. The indicator light shines green*, indicating that the loudspeaker is switched on.

When you switch off your Bang & Olufsen system, the indicator light becomes solid red for a while and then switches off (standby).

If the loudspeaker is connected to a non-Bang & Olufsen system, refer to the next page for information about switching on and off, turning the volume up and down, shifting the sound balance, and presetting the volume level.

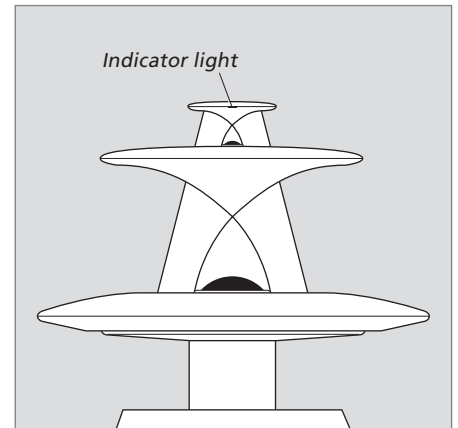

Do not touch the two speaker domes! For cleaning, use a soft brush.

Loudspeaker protection

The loudspeaker is equipped with a thermal protection system which prevents the units from overheating. Should an error occur, the system automatically switches the loudspeaker to standby – and the indicator light flashes red for a while.

To restore the situation:

- > Disconnect the loudspeaker from the mains.
- > Allow the system time to reset (approx. 3–5 minutes).
- > Reconnect the loudspeaker to the mains again.

Should the problem persist, contact your Bang & Olufsen retailer.

Cleaning

Clean the loudspeaker surfaces using a soft, lint-free cloth which you have wrung firmly in lukewarm water.

Never use a vacuum cleaner to clean the two domes. However, the front speaker cloth may be cleaned with a vacuum cleaner with a brush nozzle, and set to the lowest suction level.

Never use alcohol or other solvents to clean any parts of the loudspeaker.

*NOTE! If the *Adaptive Bass Control* system has not yet been calibrated, the indicator light slowly flashes green. The calibration is explained in *Adapt BeoLab 5 to your room* (pp. 12–13). If the loudspeaker has been locked by the PIN code system, the indicator light shines intermittently red and green. The PIN code system is explained in *Use the PIN code system* (p. 14).

Use BeoLab 5 with a non-Bang & Olufsen system

The loudspeakers must be connected as explained on page 10, and the *Option* number set to 1 or 4, as explained on page 11.



Operate your non-Bang & Olufsen system as you normally would. However, you will have to use a Beo4 remote control (optional accessory) to do the following:

- Switch the loudspeakers on and off;
- Turn the volume level up or down;
- Adjust the left–right sound balance (when you switch on the loudspeakers, the balance is always neutral);
- Store and reset sound levels;
- Use the PIN code system;
- Change *Option* setting and LINE input level.

Although *BASS*, *TREBLE*, *LOUDNESS* are available in the Beo4 display you cannot adjust these levels using Beo4. We recommend that you keep any tone control settings neutral.

For specific information about the Beo4 remote control, please refer to its own guide.

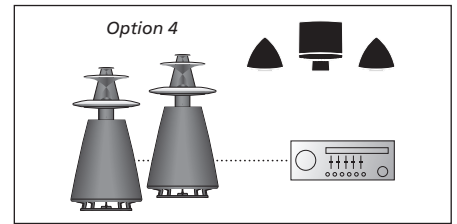
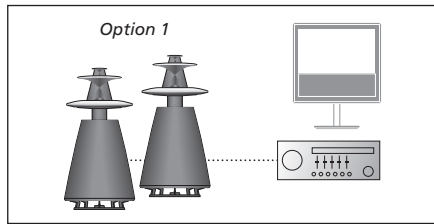

If BeoLab 5 is programmed to *Option 1*

To switch BeoLab 5 on/off...

- > Press **RADIO** to switch on.
- > Press **•** to switch off.

To turn the volume level up/down...

- > Press **^** to turn the volume up.
- > Press **v** to turn the volume down.

To reset the sound level...

- > Press **LIST**, until **RESET*** is shown in the Beo4 display
- > Press the **centre** button to reset sound level.

To shift the left–right sound balance...

- > Press **◀** to shift the sound towards the left, and press **▶** to shift the sound towards the right.

To store a new start up sound level...

- > Press **^v** until you reach your preferred start up sound level.
- > Press **LIST** until **A.SETUP*** is shown in the Beo4 display.
- > Press the **centre** button to accept.
- > Press **LIST** until **S.STORE** is shown in the Beo4 display.
- > Press the **centre** button to store the setting.

If BeoLab 5 is programmed to *Option 4*

To switch BeoLab 5 on/off...

- > Press **LIST** until **LINK*** is shown in the Beo4 display, and then **RADIO** to switch on.
- > Press **•** to switch off.

To turn the volume level up/down...

- > Press **^** to turn the volume up.
- > Press **v** to turn the volume down.

To reset the sound level...

- > Press **LIST** until **RESET*** is shown in the Beo4 display.
- > Press the **centre** button to reset sound level.

To shift the left–right sound balance...

- > Press **◀** to shift the sound towards the left press **▶** to shift the sound towards the right.

To store a new start up sound level...

- > Press **^v** until you reach your preferred start up sound level.
- > Press **LIST** until **A.SETUP*** is shown in the Beo4 display.
- > Press the **centre** button to accept.
- > Press **LIST** until **S.STORE** is shown in the Beo4 display.
- > Press the **centre** button to store the setting.

*Must be added to the Beo4 LIST-function. See the Beo4 online guide at www.bang-olufsen.com/guides.

Setting up BeoLab 5

We recommend that you follow this procedure:

- Disconnect your audio or video system from the mains;
- Make all the connections as described in *Cable connections* (pp. 8–10);
- Connect the loudspeakers to the mains;
- If necessary, program the loudspeakers to your audio or video system, as described in *Adapt BeoLab 5 to your system* (p. 11);
- Let the loudspeakers perform the *Adaptive Bass Control* calibration, as described in *Adapt BeoLab 5 to your room* (pp. 12–13);
- If you wish to activate the PIN code system, you may now do so. This is explained in *Use the PIN code system* (pp. 14–16);
- Connect your audio or video system to the mains again.

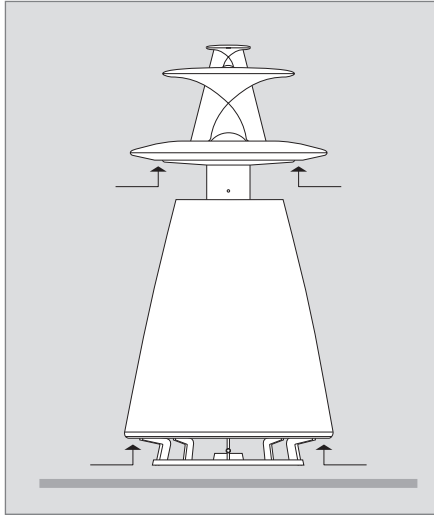

Handling BeoLab 5: Due to its heavy weight, any moving or lifting should always be done by two persons. 'Safe areas' to hold when moving/lifting the loudspeaker are indicated in the illustration.

Do not move the loudspeaker without lifting it clear of the floor, as damage to the floor may result!

Cautions

- Do not attempt to open the loudspeaker. Leave such operations to qualified service personnel!
- Make sure that the loudspeaker is placed and connected in accordance with the instructions in this Guide.
- Place the loudspeaker on the floor.
- Do not place any items on top of the loudspeaker.
- Do not touch the two speaker domes! See *Cleaning BeoLab 5* (p. 4) for further information.
- The loudspeaker is designed for indoor use in dry, domestic environments only, and for use within a temperature range of 10–40° C (50–105° F).

Before you start ...

- If you connect the loudspeaker to a non-Bang & Olufsen system, you will need a Beo4 remote control (optional accessory), in order to be able to operate the loudspeaker, e.g. switching on and off, turning the volume level up or down, etc.
- Volume levels are adjusted in the built-in loudspeaker amplifiers, not in your audio or video system, and we recommend that you keep any tone control settings neutral.
- Remember that all loudspeakers in a setup must be connected to the mains.

Warning

- Prolonged listening at a high volume level may cause hearing damages!

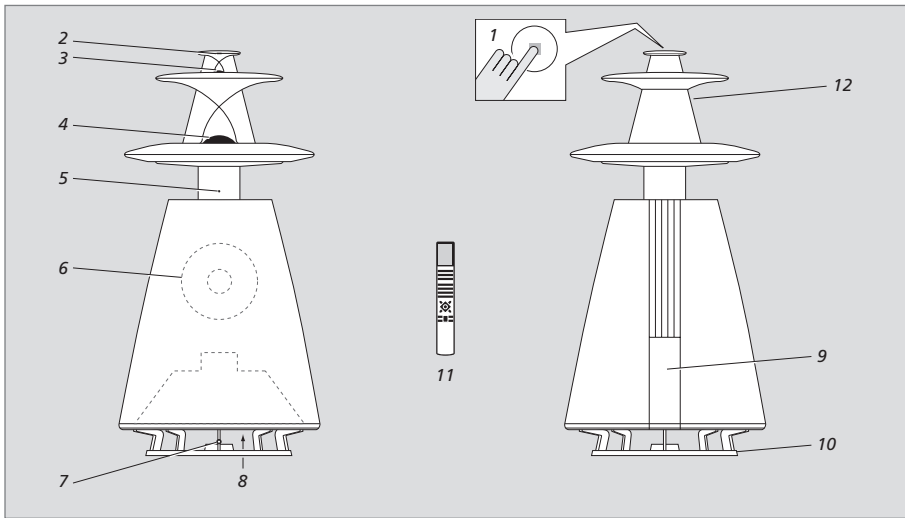

The illustration to the left shows the placement of different parts:

- 1 Touch field
- 2 Indicator light
- 3 High frequency speaker dome – *do not touch!*
- 4 Mid frequency speaker dome – *do not touch!*
- 5 Receiver for Beo4 remote control signals
- 6 Upper bass speaker unit
- 7 Moving microphone for the *Adaptive Bass Control* system
- 8 Lower bass speaker unit
- 9 Cover for socket panel
- 10 Base
- 11 Beo4 remote control (optional accessory)
- 12 Product label

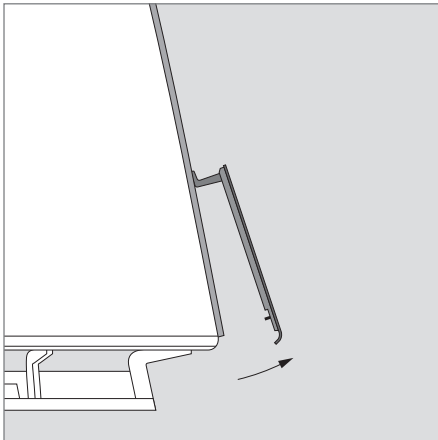

Cover for socket panel: To get access to the sockets and the RIGHT-LEFT switch, you will have to remove the cover. To do so, pull out the bottom edge of the cover, as illustrated above

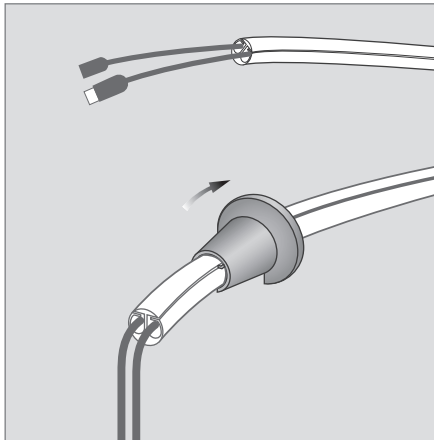

Cable cover: Place the mains lead and the signal cables inside the enclosed cable cover, and then use the special tool to seal the cover.

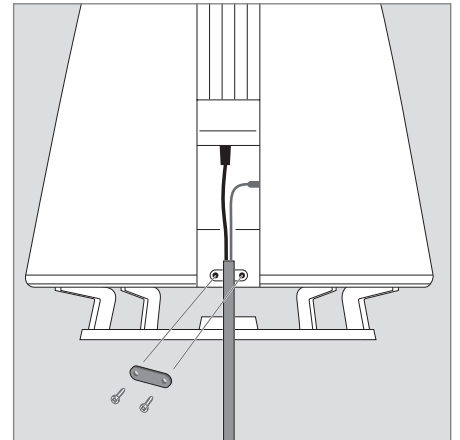

Cable clamp: For safety reasons the mains lead must be secured to the loudspeaker. To do so, place the cable cover with the cables behind the clamp, and tighten the two screws.

Connect cables

The loudspeaker can be connected to Bang & Olufsen audio and video systems as explained on page 9. It may also be connected to non-Bang & Olufsen systems as explained on page 10.

Use the illustrations and the graphics imprinted on the socket panel when locating the sockets and the switch.

For specific information about the sockets on your audio or video system, please refer to the Guide enclosed with the system.

To get access to the panel, remove the cover on the rear of the loudspeaker as explained on page 7.

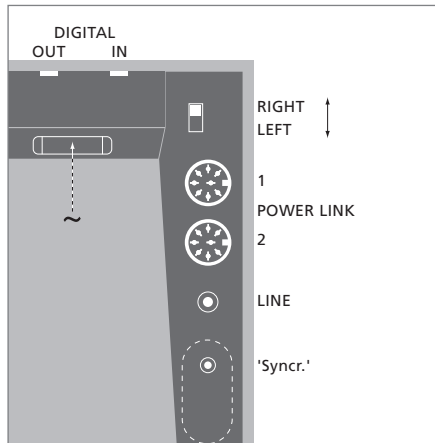

The 'Syncr. connection' is hidden beneath a small cover. To get access, just pry the cover off.

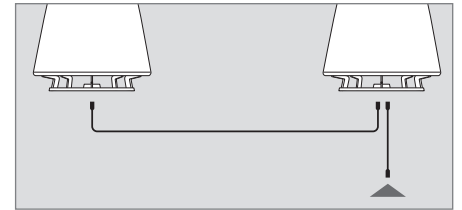
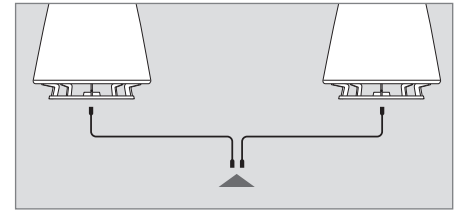

Power Link cables may be run in two ways, as illustrated here.

Socket and switch panel

DIGITAL OUT

Phono socket/RCA socket used to forward the digital signal from the first loudspeaker to the next (SPDIF unbalanced).

Digital connections carry both the right and left sound channels.

DIGITAL IN

Phono socket/RCA socket used for connection to a system with a digital output (SPDIF unbalanced). Digital connections carry both the right and left sound channels.

~

Socket for connection to the mains supply.

RIGHT – LEFT

This switch sets the loudspeaker to play either the right or the left sound channel. Set this switch to RIGHT or LEFT respectively, when connecting the loudspeaker using any of the sockets marked POWER LINK, or the sockets marked DIGITAL.

When you connect the loudspeaker using the socket marked LINE only, you may leave the switch in either position.

POWER LINK 1 – 2

Sockets for connection to Bang & Olufsen audio or video systems.

Power Link connections carry both the right and left sound channels.

LINE

Phono socket/RCA socket for connection to non-Bang & Olufsen audio or video systems. The LINE signal must be a non-regulated line signal (≤ 2 V RMS). If the LINE output level exceeds 2 V RMS, you must change the LINE input level on each loudspeaker – as explained in *Adapt BeoLab 5 to your system* (p. 11).

'Syncr. connection'

Socket for connection between two BeoLab 5 speakers in a setup. Used when connecting to non-Bang & Olufsen systems only. The connection ensures that both loudspeakers always play at the same volume level.

The supplied plug and mains cord are specially designed for the product. Do not change the plug and if the mains cord is damaged, you must buy a new one from your Bang & Olufsen retailer.

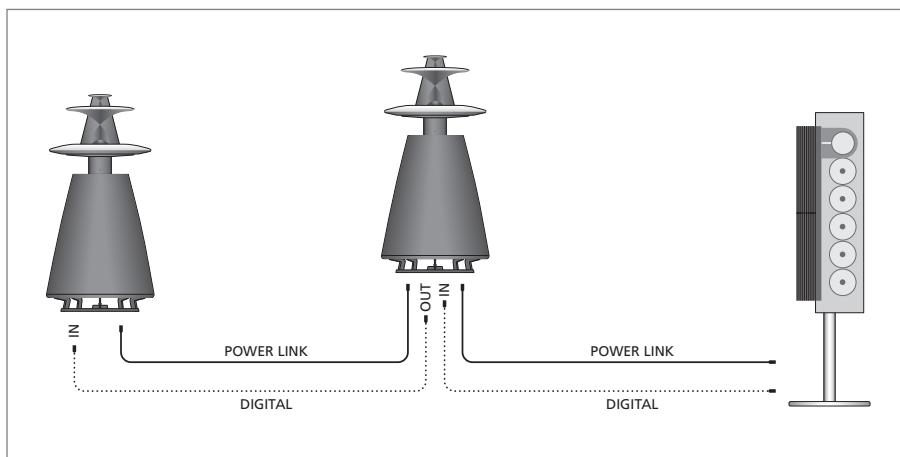

Connection to Bang & Olufsen systems

The loudspeaker can be connected to all Bang & Olufsen audio and video systems equipped with Power Link sockets. It can also be connected to Bang & Olufsen systems that have a digital output socket.

Remember to set the switch marked RIGHT-LEFT to the correct position on each loudspeaker!

POWER LINK connections

Use Bang & Olufsen Power Link cables to connect the loudspeakers to your system. Power Link connections may be run in two ways as explained on page 8.

Longer cables are available from your Bang & Olufsen retailer. However, you should not use longer cables than necessary.

IMPORTANT: Use fully mounted Power Link cables only – not the very thin type! If the wrong type of Power Link cables are used, the loudspeaker will not play. If in doubt, ask your Bang & Olufsen retailer.

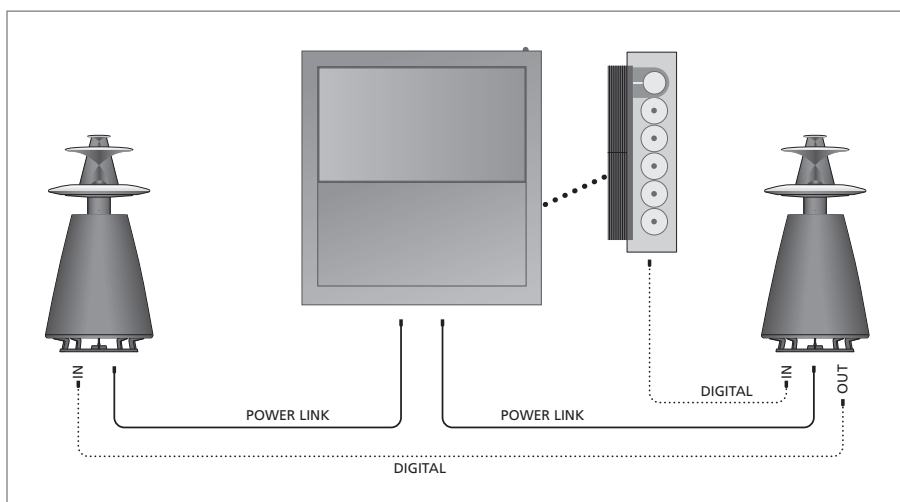

For connections in other Bang & Olufsen digital systems, please refer to the Guide enclosed with those systems

DIGITAL connections

If your Bang & Olufsen system has a digital output socket, we recommend that you connect the loudspeakers directly to this socket as well. This ensures optimal sound quality when playing digital sources (CD's). Use Bang & Olufsen approved phono cables to connect the loudspeakers to your system.

Connection to non-Bang & Olufsen systems

The loudspeaker may be connected to most non-Bang & Olufsen audio or video systems equipped with a non-regulated LINE level output (volume levels are adjusted in the built-in loudspeaker amplifiers, not in the audio or video system).

The loudspeaker may also be connected to most systems with a digital output socket (SPDIF).

When connecting to non-Bang & Olufsen systems, remember to change the 'Option' setting to either 1 or 4, as explained in 'Adapt BeoLab 5 to your system' (p. 11).

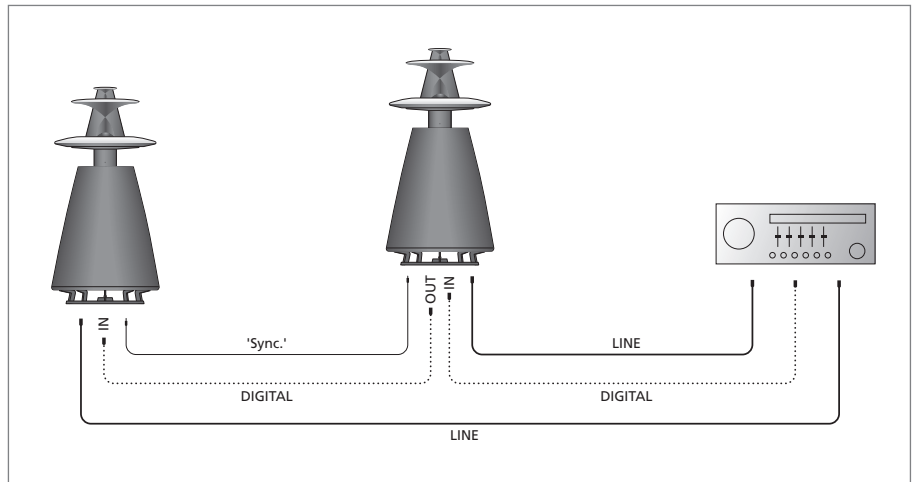

LINE connections

Use ordinary phono cables to connect each loudspeaker directly to your system.

If the LINE output level exceeds 2 V RMS, you must set each loudspeaker to accommodate a higher input level ($> 2 \text{ V RMS} \leq 4 \text{ V RMS}$), as explained in *Adapt BeoLab 5 to your system* (p. 11).

'Syncr.' connection

Connection between the two loudspeakers. The connection ensures that both loudspeakers always play at the same volume level.

Use a Bang & Olufsen approved cable with a mini-jack plug in each end to connect the two loudspeakers in a setup.

DIGITAL connections

If your system has a digital output socket, we recommend that you connect the loudspeakers to this socket as well. This ensures optimal sound quality when playing digital sources.

Use Bang & Olufsen approved phono cables to connect the loudspeakers to your system.

When using digital connections, remember to set the switch marked RIGHT-LEFT to the correct position on each loudspeaker!

The loudspeaker is set to *Option* number 0 from the factory. Therefore, when you connect the loudspeaker to a Bang & Olufsen audio or video system, it is not necessary to change the Option setting. In this case, the loudspeakers are controlled via the Bang & Olufsen system.

However, when the loudspeaker is connected to a non-Bang & Olufsen system, you must change the *Option* setting. In this case, the Beo4 remote control signals are received and processed by the loudspeakers. Two different Option settings are available – which to use depends on your setup.

If the **LINE** output level of your non-Bang & Olufsen system exceeds 2 V RMS, you must set the loudspeakers to accommodate a higher input level (> 2 V RMS 4 V RMS).

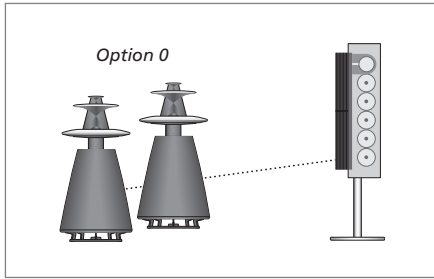

Option 0 (factory setup): Used if connected to a Bang & Olufsen audio (or video) system.

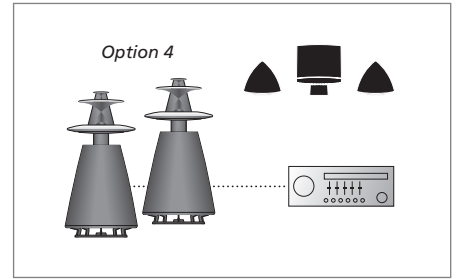

Option 4: Used if connected to a non-Bang & Olufsen system – and you have an extra Bang & Olufsen audio system in the same room.

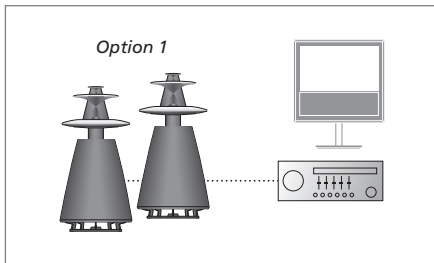

Option 1: Used if connected to a non-Bang & Olufsen system. You may have a Bang & Olufsen television in the same room, if you wish.

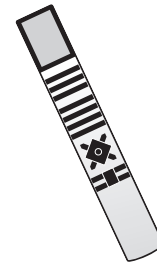

A Beo4 remote control is used to change the 'Option' and the LINE input level setting.

To change the Option setting:

- > While holding down the **•** button, press **LIST**.
- > Let go of both buttons.
- > Press **LIST** repeatedly until **OPTION?** is shown in the Beo4 display.
- > Press the **centre** button.
- > Press **LIST** repeatedly until **L.OPT** is shown in the Beo4 display.
- > Key in the appropriate Option number (**0**, **1** or **4**).

The indicator light switches off briefly, confirming that the new Option number has been stored. To ensure that all loudspeakers are programmed to the correct number, repeat the procedure for each loudspeaker separately.

To change the LINE input level setting:

- > Press **LIST** repeatedly until **SOUND*** is shown in the Beo4 display.
- > Press the **centre** button.
- > Key in the appropriate LINE input level number (1 if LINE input level < 2 V RMS; 2 if LINE input level > 2 V RMS ≤ 4 V RMS).

The indicator light switches off briefly, confirming that the new LINE input level has been stored. To ensure that all loudspeakers are set to the same LINE input level, repeat the procedure for each loudspeaker separately.

*Must be added to the Beo4 LIST-function. To do so, refer to the Beo4 online guide.

Adapt BeoLab 5 to your system

The *Acoustic Lens Technology* system in BeoLab 5 ensures better balance between sound in the high and mid tone frequencies coming directly from the loudspeaker, and sound reflected by the room. The *Acoustic Lens Technology* system also ensures correct tonal balance in the whole area in front of the loudspeaker.

The BeoLab 5 *Adaptive Bass Control* system and the *Acoustic Lens Technology* system ensures optimum freedom in the placement of your loudspeakers. Performing a calibration of the *Adaptive Bass Control* system ensures that the loudspeaker is optimally suited to its placement and the surroundings – and therefore, gives the best possible sound quality

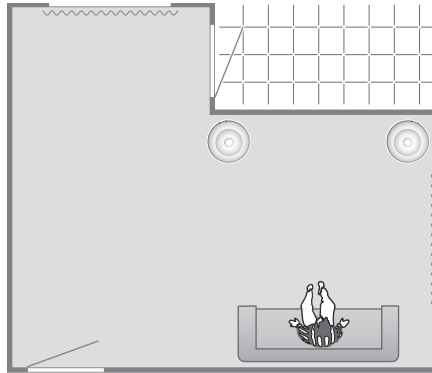

The 'Adaptive Bass Control' calibration ensures that the bass level suits the placement of the loudspeaker, and thus the surroundings.

When you switch the loudspeaker on for the first time, the indicator light flashes slowly green* – signalling that it has not yet been calibrated.

Adaptive Bass Control calibration

Normally, when a loudspeaker is placed in a corner, the bass level is boosted compared to the bass level in a loudspeaker placed in a more freestanding position.

With other speaker systems, you have to consider this when placing them. With BeoLab 5, the Adaptive Bass Control system – when calibrated – filters out this change in the bass level.

During the calibration, the loudspeaker generates a series of sound signals and measures the response from walls, the floor, the ceiling, large objects and other surfaces in the room. Based on these measurements, the loudspeaker automatically calculates optimal settings for the *Adaptive Bass Control* filter.

Important!

- Before you start the calibration, place the loudspeaker where you want it to be.
- Do not calibrate more than one loudspeaker at a time. Otherwise, the sound emitted from one loudspeaker interferes with the measurements done in the other, and vice versa.
- Consider the 'normal status' of the listening room: Will the doors be closed...? Will the windows...? Will the curtains be drawn...? Will there be many people in the room...?
- If you, later on, decide to move the loudspeakers, rearrange your room, carpet the floor, etc., we recommend that you perform the calibration for each loudspeaker once again.
- We recommend that you keep any tone control settings neutral.

During the calibration make sure that no noise interferes with the sounds emitted by the loudspeaker. Such noise might, for example, be: a running vacuum cleaner, ventilation or air conditioning systems, motor sounds nearby, etc.

Up to a certain level, the loudspeaker will try to compensate for this noise, but eventually, the noise may cause the calibration to fail – indicated by a slowly flashing red light. Should this happen, you must restart the calibration – perhaps later on, when the noise has stopped...

To calibrate BeoLab 5

Perform the calibration for each loudspeaker in your setup separately. The calibration takes a couple of minutes for each loudspeaker. You cannot start the calibration if the loudspeaker has been locked by the PIN code system*.

- > Make sure that the loudspeaker is in standby. If necessary, switch the loudspeaker to standby as explained in the chapter 'Daily use' (pp. 4–5).
- > Press and hold the touch field for more than three seconds, then let go of the panel. *When the calibration begins, the indicator light flashes green.*

Once started, and during the calibration, the following occurs:

- The microphone extends a little, and the speaker generates a series of sound signals, starting with very low bass tones.
- After a while the microphone extends a little further, and the sound signals begin again.
- When the calibration is complete, the microphone retracts and the loudspeaker switches to standby. The indicator light shines red for a while. You may now proceed with the next loudspeaker.

If the indicator light flashes red, an error has occurred during the calibration. To solve this, do the following:

- > Press and hold the touch field for more than one second, then let go of the field. *The loudspeaker will switch to standby, and the indicator light shines red for a while*
- > Check for any source of noise which may have interfered with the calibration, and wait until the noise has stopped.
- > Press and hold the touch field for more than three seconds to start the calibration again.

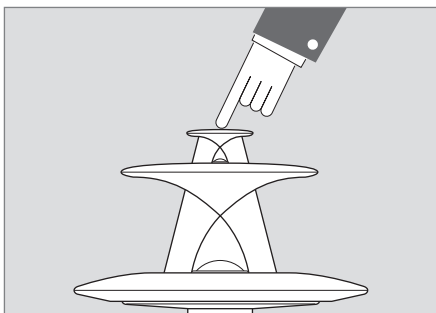

Press and hold the touch field for more than three seconds on the loudspeaker you wish to calibrate (while you are pressing, the indicator light quickly flashes red).

If you wish to cancel an ongoing calibration, press the touch field again – or press BACK on the Beo4 remote control.

For an overview of the indicator lights, refer to page 17.

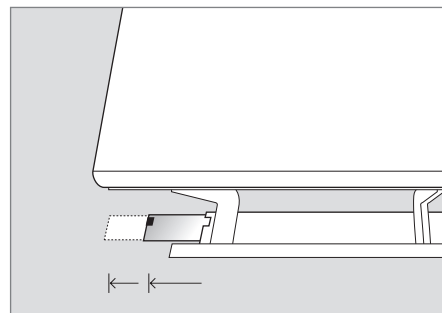

The moving microphone is used during the calibration. Make sure that there is always free space in front of the microphone.

*NOTE! If the loudspeaker is locked by the PIN code system, the indicator light shines intermittently red and green when you switch on. Unlock the loudspeaker as explained in Use the PIN code system (p. 14).

Use the PIN code system

The loudspeaker has a built-in PIN code protection system. You decide whether or not to activate it.

If you choose to activate the PIN code system, and if the loudspeaker is disconnected from the mains for more than 15–30 minutes, it will only play for a five minute period upon reconnection – and then automatically switch to standby. In this case, you must key in your own personally chosen PIN code with a Beo4 remote control, to unlock the loudspeaker

PIN code system setup

For your own convenience we suggest that you choose the same four-digit PIN code for all your Bang & Olufsen products. However, you cannot use the code '0000', as this is reserved for use when deactivating the PIN code system.

To activate the PIN code system

You activate the PIN code system for each loudspeaker in your setup separately.

While BeoLab 5 is in standby...

- > Press **◀◀**, **▶▶**, and **STOP** in quick succession on the Beo4 remote control.
The indicator light shines intermittently red (0.5 sec.) and green (1 sec.).
- > Within 10 seconds, press the touch field on top of the loudspeaker you wish to activate. *The loudspeaker confirms your selection with a sound signal.*
- > Key in a four-digit PIN code of your own choice*. *The loudspeaker confirms each digit with a sound signal.*
- > Press the **centre** button to accept your code. *The loudspeaker confirms this with a sound signal.*
- > To confirm your chosen code, key in the fourdigit code again*. *The loudspeaker again confirms each digit with a sound signal.*
- > Press the **centre** button to store your code. *The loudspeaker confirms this with a sound signal.*

If the PIN code is accepted, the indicator light shines red for a while.

If it is not accepted, the loudspeaker emits a sound signal, and you will have to start over again with the four-digit code.

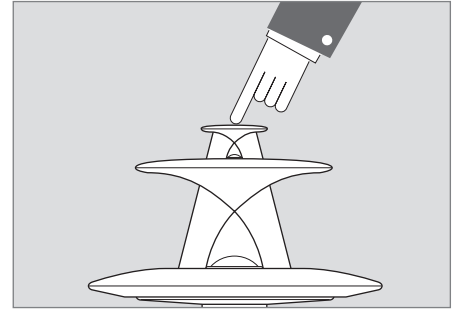

Press the touch field on the loudspeaker you wish to activate (while you are pressing the field, the indicator light quickly flashes red).

*If you wish to skip an ongoing activation, you can do so by touching the touch field again (or pressing **BACK** on the Beo4 remote control).*

We recommend that you disconnect your other Bang & Olufsen products in the room from the mains while setting-up the PIN code system. This prevents them from, for example, switching on, when you press the buttons on the Beo4 remote control.

For an overview of the indicator lights and the sound signals, refer to page 17.

*NOTE! If you make a mistake, press **STOP** and then start digit entry over again.

To change your PIN code

In order to change the PIN code, you must first key in your previously chosen four-digit code, and then key in a new code. However, you can only do so five times within a three-hour time period!

While BeoLab 5 is in standby...

- > Press **◀, ▶**, and **STOP** in quick succession on the Beo4 remote control.
The indicator light shines intermittently red (1 sec.) and green (0.5 sec.).
- > Within 10 seconds, press the touch field on top of the loudspeaker you wish to change the PIN code for.
The loudspeaker confirms your selection with a sound signal.
- > Key in your previously chosen four-digit PIN code*.
The loudspeaker confirms each digit with a sound signal.
- > Press the **centre** button to be able to enter your new four-digit code.
The loudspeaker confirms this with a sound signal.
- > Key in a new four-digit code of your own choice*.
The loudspeaker confirms each digit with a sound signal.
- > Press the **centre** button to accept your code.
The loudspeaker confirms this with a sound signal.
- > To confirm your new code, key in the new four-digit code again*.
The loudspeaker confirms each digit with a sound signal.
- > Press the **centre** button to store your code.
The loudspeaker confirms this with a sound signal.

If the PIN code is accepted, the indicator light shines red for a while and then switches off.
If it is not accepted the loudspeaker emits a sound signal, and you will have to start over again with the four-digit code.

If you have forgotten your PIN code

You will need a five-digit master code in order to unlock the loudspeaker. Please contact your Bang & Olufsen retailer to get a master code from Bang & Olufsen.

When unlocked via a master code the PIN code system is deactivated!

While BeoLab 5 is in standby...

- > Press and hold **◀** on the Beo4 remote control for three seconds to enable master code input.
The indicator light shines intermittently red (1 sec.) and green (0.5 sec.).
- > Within 10 seconds, press the touch field on top of the loudspeaker you wish to activate.
The loudspeaker confirms your selection with a sound signal.
- > Key in the five-digit master code you received from Bang & Olufsen*.
The loudspeaker confirms each digit with a sound signal.
- > Press the **centre** button to enter the five-digit master code.
The loudspeaker confirms this with a sound signal.

If the master code is accepted, the indicator light shines red for a while and then switches off.
If it is not accepted the loudspeaker emits a sound signal, and you will have to start over again with the five-digit master code.

To deactivate the PIN code system

In order to deactivate the PIN code system you must first key in your previously chosen four-digit code, and then key in the '0000-code', which disables the function.

While BeoLab 5 is in standby...

- > Press **◀, ▶**, and **STOP** in quick succession on the Beo4 remote control.
The indicator light shines intermittently red (1 sec.) and green (0.5 sec.).
- > Within 10 seconds, press the touch field on top of the loudspeaker you wish to deactivate.
The loudspeaker confirms your selection with a sound signal.
- > Key in a your previously chosen four-digit PIN code*.
The loudspeaker confirms each digit with a sound signal.
- > Press the **centre** button to enter your code.
The loudspeaker confirms this with a sound signal.
- > Key in the digits 0 0 0 0 on the Beo4 remote control*.
- > Press the **centre** button to deactivate the PIN code system.

The indicator light shines red for a while and then switches off.
If it is not accepted the loudspeaker emits a sound signal, and you will have to start over again with the '0000 code.

If you have used the same four-digit PIN code for all your Bang & Olufsen products, you can easily unlock them in one step – just remember to place yourself in a position so all units are able to receive the Beo4 remote control signals.

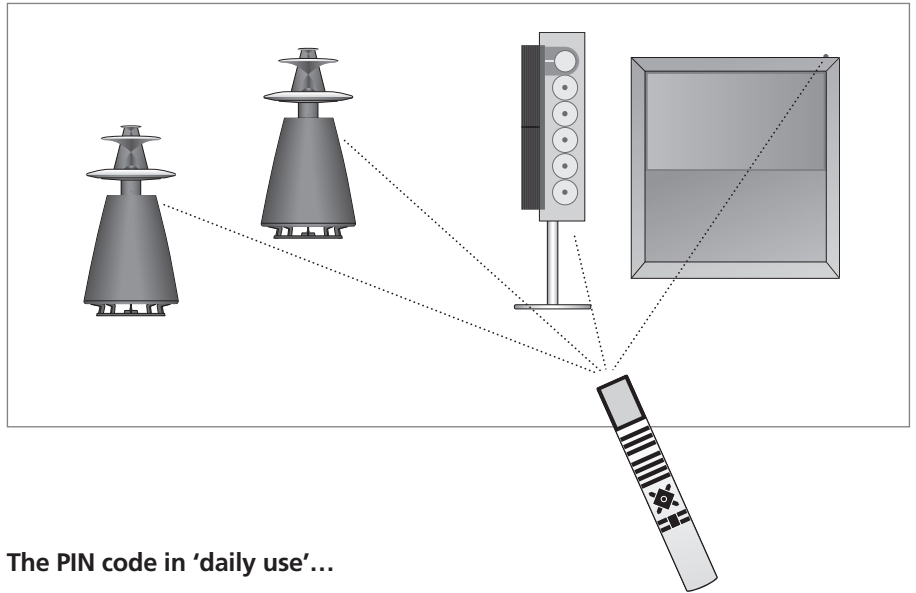

The PIN code in 'daily use'...

In daily use you will not notice the PIN code system. However, if the loudspeaker has been disconnected from the mains for more than 15–30 minutes (or if there has been a longer power failure in your area) the activated PIN code system will only allow the loudspeaker to play for approximately five minutes before it automatically switches to standby.

In this case, in order to unlock the loudspeaker, you must key in your personally chosen PIN code with a Beo4 remote control.

Should you enter a wrong PIN code, you only have four more attempts to key in the correct code, after which the loudspeaker is switched off and cannot be switched on for three hours! During these three hours the loudspeaker must remain connected to the mains power.

To unlock BeoLab 5

If the loudspeaker is locked by the PIN code system the indicator light slowly flashes red and green when you switch on.

While BeoLab 5 is playing...

> Key in your four-digit PIN code on the Beo4 remote control*.

The loudspeaker confirms each digit with a 'beep'.

If the PIN code is accepted, the indicator light now shines green – indicating that the loudspeaker has been unlocked.

If the PIN code is not accepted, the loudspeaker emits a sound signal, and you will have to start over again with the four-digit code.

**If you make a mistake, press STOP and then start digit entry over again.*

In daily use, you will see that the indicator light shines either red for a while (standby) or green (playing).

In different situations, you may see other indications, such as a flashing red or green light, and combinations of these colours. When setting up the PIN code system, you will also hear sound signals from the loudspeaker.

These instances are explained in the relevant chapters throughout this Guide, but to give you an overview, all instances are explained on this page. In the overview, you will find page references to relevant chapters

Indicator light:	Loudspeaker status:
Shines RED for a while and switches off...	The loudspeaker is in standby (p. 4).
Shines GREEN...	The loudspeaker is on (p. 4).
Flashes RED/OFF (1 sec./1 sec.) for approx. 12 seconds	Internal loudspeaker error (p. 4).
Flashes RED (very quickly)...	You are pressing the touch field.
Flashes intermittently GREEN/OFF (1 sec./1 sec.)...	<i>Adaptive Bass Control</i> calibration in progress (pp. 12–13).
Flashes intermittently RED/OFF (0.5 sec./0.5 sec.)...	An error occurred during <i>Adaptive Bass Control</i> calibration (pp. 12–13).
Flashes intermittently GREEN/OFF (2 sec./0.5 sec.)...	<i>Adaptive Bass Control</i> calibration has not yet been performed (pp. 12–13).
Flashes intermittently RED/GREEN (0.5 sec./1 sec.)...	Activation of the PIN code system in progress (p. 14).
Flashes intermittently RED/GREEN (1 sec./0.5 sec.)...	Indicates either: <ul style="list-style-type: none"> – Deactivation of the PIN code system in progress (p. 15); – Changing of the PIN code in progress (p. 15); – Input of a master code in progress (page 15).
Flashes intermittently RED/GREEN (1 sec./1 sec.)...	The loudspeaker has been locked by the PIN code system (p. 16).
Switches briefly OFF, and then shines red again...	<i>Option</i> setting has been accepted (p. 11).

Sound signal:	Loudspeaker status:
Emits a brief sound ('ding')...	Indicates one of these two instances related to the PIN code system (pp. 14–15): <ul style="list-style-type: none"> – The loudspeaker has been selected; – Digit entry.
Emits a double-sound ('dong-ding')...	PIN or master code has been accepted (pp. 14–15).
Emits a series of sounds ('ding-dong, dingdong, ding-dong')...	PIN code has not been accepted (pp. 14–15).

Index

Acoustic Lens Technology

Adapt BeoLab 5 to your room, 12–13

Adaptive Bass Control

Adapt BeoLab 5 to your room, 12–13

Daily use, 4

Indicator lights and sound signals, 17

Audio or video system

Adapt BeoLab 5 to your system, 11

Connection to Bang & Olufsen systems, 9

Connection to non-Bang & Olufsen systems, 10

Daily use, 4–5

Use the PIN code system, 14–16

Beo4 remote control

Daily use, 4–5

Adapt BeoLab 5 to your system, 11

Use the PIN code system, 14–16

Cables and connections

Connection to Bang & Olufsen systems, 9

Connection to non-Bang & Olufsen systems, 10

Setting up BeoLab 5, 6–7

Sockets and switch panel, 8

Calibration

Adapt BeoLab 5 to your room, 12–13

Daily use, 4

Indicator lights and sound signals, 17

Cleaning

Cleaning, 4

Indicator lights and sound signals

Adapt BeoLab 5 to your room, 12–13

Adapt BeoLab 5 to your system, 11

Daily use, 4

Indicator lights and sound signals, 17

Setting up BeoLab 5, 7

Use the PIN code system, 14–16

Loudspeaker protection

Cleaning BeoLab 5, 4

Indicator lights and sound signals, 17

Loudspeaker protection, 4

Maintenance

Cleaning, 4

Option settings

Adapt BeoLab 5 to your system, 11

Indicator lights and sound signals, 17

Use BeoLab 5 with a non-Bang & Olufsen system, 5

PIN code

Daily use, 4

Indicator lights and sound signals, 17

PIN code system setup, 14–15

The PIN code in 'daily use', 16

Placement

Adapt BeoLab 5 to your room, 12–13

Setting up BeoLab 5, 7

Waste Electrical and Electronic Equipment (WEEE) – Environmental protection



Electrical and electronic equipment, parts and batteries marked with this symbol must not be disposed of with normal household wastage; all electrical and electronic equipment, parts and batteries must be collected and disposed of separately.

When disposing of electrical and electronic equipment and batteries by use of the collection systems available in your country, you protect the environment, human health and contribute to the prudent and rational use of natural resources.

Collecting electrical and electronic equipment, batteries and waste prevents the potential contamination of nature with the hazardous substances which may be present in electrical and electronic products and equipment. Your Bang & Olufsen retailer will advise you of the correct way of disposal in your country.

