

BeoVision 7

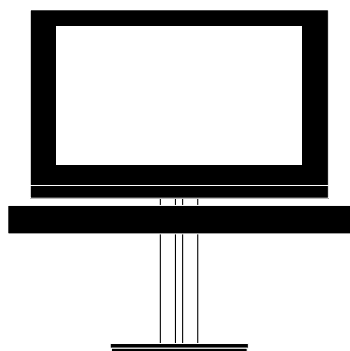

Contents

Menu overview, 3

See an overview of on-screen menus.

Blu-ray menu overview, 4

See an overview of the Blu-ray menu.

Navigate in menus, 5

See how to use the different remote controls for menu operation.

First-time setup, 6

Which menus appear when you switch on the television for the very first time.

Choose menu language, 8

How to select a menu language.

Set positions for the television to turn to, 9

How to preset positions for a motorised stand to turn to.

Tuner setup, 10

How to disable the internal TV tuner or built-in DVB-HD module.

Connections, 11

Examples of where to connect additional equipment and how to connect a PC or camera.

Register additional video equipment, 15

How to register connected equipment in the CONNECTIONS menu.

Edit tuned TV channels, 18

How to rearrange the order in which channels appear in the channel list and how to name or delete them.

Re-tune or add channels, 21

How to add new channels or how to make a new automatic tuning.

Loudspeaker setup – surround sound, 22

How to make your television part of a surround sound system.

Adaptive Sound Technology, 27

How to set up loudspeakers and optimise the sound experience with Adaptive Sound Technology.

Adjust picture and sound settings, 32

How to make settings for picture and how to adjust bass, treble, etc. How to use game mode.

Set up 3D television, 35

How to make settings for when you watch 3D television.

Daily use of speaker combinations, 37

How to switch between different speaker combinations.

See two sources at the same time, 38

How to see two sources at the same time.

Home cinema, 39

How to set up your system for Home cinema.

Set the television to switch itself on or off, 40

How to make your television switch off automatically or make it part of a PLAY TIMER. How to make auto standby settings and save power.

Wake-up Timer, 43

How to make your television wake you up in the morning.

Set the time and date, 45

How to set the time and date.

Settings and preferences for the Blu-ray player, 46

How to make settings and preferences for the Blu-ray player and its parental lock function.

Blu-ray player - media browser, 48

How to browse your photos and playback your music files on your television .

The pincode system, 49

How to use the pincode system.

Set up your remote control, 51

Tell the television if the navigation button on your remote control is enabled or disabled.

Feature activation, 52

How to enter an activation key and get access to additional features.

HDMI MATRIX, 53

How to enter settings in the HDMI MATRIX menu.

Teletext, 55

How to store favourite teletext pages as MEMO pages.

Operate other equipment with Beo6 or Beo4, 56

How to operate connected equipment, such as set-top boxes, DVD players or the like.

Connect and operate an audio system, 58

How to connect an audio system to your television and operate an integrated audio/video system.

Distribute sound and picture with BeoLink, 61

How to make link connections, operate a link system.

Your television in a link room, 63

How to set up and operate your television in a link room.

Two televisions in the same room, 65

Option programming and operation of two televisions in the same room.

Menu overview

1.	2.	3.
TUNING	EDIT CHANNELS ADD CHANNEL AUTO TUNING MANUAL TUNING	MANUAL TUNING (EXTRA)
3D DISPLAY	3D 2D 3D SETTINGS	ACTIVATE 3D 3D SHARPNESS
SLEEP TIMER	TIMER ON/OFF	
PLAY TIMER	PLAY TIMER INDEX PLAY TIMER PROGRAMMING WAKE-UP TIMER	
OPTIONS	CONNECTIONS	AV1–AV6 PROJECTOR OUT HDMI EXPANDER LINK
	TUNER SETUP	TV TUNER DVB
	SOUND (When Adaptive Sound Technology is OFF)	ADJUSTMENT SPEAKER TYPE SPEAKER ROLES SPEAKER DISTANCE SPEAKER LEVEL SOUND SYSTEM AST ON/OFF
	SOUND (When Adaptive Sound Technology is ON)	ADJUSTMENT SPEAKER SETUP LISTENING PRESETS SOUND SYSTEM AST ON/OFF
	PICTURE CLOCK STANDBY SETTINGS	AUTO STANDBY POWER SAVING
	REMOTE CONTROL	NAVIGATION BUTTON NO NAVIGATION BUTTON
	FEATURE ACTIVATION MENU LANGUAGE	
STAND POSITIONS	VIDEO AUDIO STANDBY STAND ADJUSTMENT	

Blu-ray menu overview

1.

SETUP

2.

PLAYBACK STATUS

AUDIO FORMAT

VIDEO FORMAT

LANGUAGE

ACCESS CONTROL

ADVANCED

3.

STANDARD

EXTENDED

STANDARD

RE-ENCODE

BITSTREAM

24 HZ ON

24 HZ OFF

AUDIO

SUBTITLES

DISC MENU

PARENTAL LOCK

RATING

NEW ACCESS CODE

MEMORY MANAGEMENT

NETWORK

MODULE INFORMATION

SOFTWARE UPDATE

Navigate in menus

Beo6

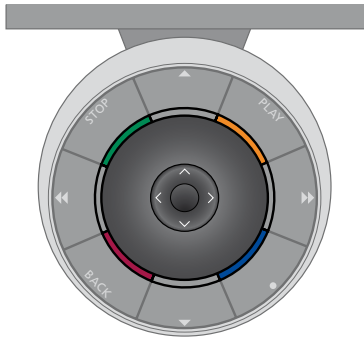

If you operate your television with the Beo6 remote control, you use the centre button with up, down, left and right movement to navigate in menus. Press in the middle of the centre button to confirm selections and settings in menus.

Bring up the TV SETUP menu by pressing **Menu** while the TV is on.

To back up through menus, press **BACK**.
To exit menus, press and hold **BACK**.

If your Beo6 is set up to be used without navigation button, press **STOP** to back up through menus and **BACK** to exit menus.

Note that a Beo6 should be reconfigured when you add new products to your setup.

You can also operate your television with Beo5 which is operated similarly to Beo6.

Beo4 with navigation button

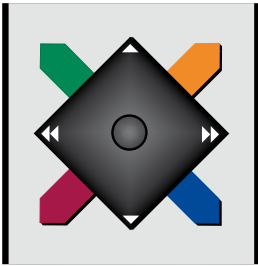

If you have a Beo4 remote control with navigation button and your television is set up for use with it, see page 51, you use the centre button with up, down, left and right movement to navigate in menus. Press in the middle of the centre button to confirm selections and settings in menus.

Bring up the TV SETUP menu by pressing **MENU** while the TV is on. If you have selected a source which has a menu overlay, you must press **MENU** twice to bring up the TV SETUP menu.

To back up through menus, press **BACK**.
To exit menu, press and hold **BACK**.

If your television is set up for use without navigation button, you must use the 'star' to navigate up, down, left and right in menus and press the centre button to confirm selections and settings in menus. To back up through menus, press **STOP**. To exit menu, press **BACK**.

Beo4 without navigation button



If you have a Beo4 remote control without navigation button, you must use the 'star' to navigate up, down, left and right in menus and press the centre button to confirm choices and settings in menus.

Bring up the TV SETUP menu by pressing **MENU** while the TV is on. If you have selected a source which has a menu

overlay, you must press **MENU** twice to bring up the TV SETUP menu.

To back up through menus, press **STOP**.
To exit menu, press **EXIT**.

First-time setup

The setup procedure is activated when the television is connected to the mains and switched on for the first time. You are led through an automatic series of on-screen menus in which you must register the extra equipment you have connected, such as a projector and loudspeakers.

If you change your setup at a later date, you can access the same menus and update your settings. Remember that you need to set the speaker types and the distances in the SOUND SETUP menu.

The contents of the first-time setup sequence varies according to the setting you make in the AST ON/OFF menu.

The sequence of menus in first-time setup

MENU LANGUAGE ... You can select the language for on-screen menus. The text on the screen changes as you move from language to language.

REMOTE CONTROL ... Enable or disable the navigation button on your remote control. [See page 51](#) for information about setting up your remote control. [See page 5](#) for information about remote controls.*

TUNER SETUP ... Disable the television tuner or DVB tuner, if you like, [see page 10](#).

CONNECTIONS ... Select the type of equipment you have connected to each socket group, the sockets used, the product name, and the source name. For further information about the CONNECTIONS menu, [see page 15](#).

CHECK AERIAL CONNECTION ... This prompt only appears if the television tuner is enabled.

AUTO TUNING ... When you have registered your connected equipment, a menu for channel tuning automatically appears on the screen. Press the **centre** button to start auto tuning. The television finds all available channels. For further information about tuning TV channels, [see page 21](#).

AST ON/OFF ... In this menu, you can choose between a speaker setup menu with or without Adaptive Sound Technology. The default setting is OFF. For further information about Adaptive Sound Technology, [see page 27](#).

Adaptive Sound Technology disabled:

SPEAKER TYPE ... In this menu, you select which speakers are connected to the television, if any. [See page 22](#) for further information.

TV SPEAKER ROLES ... In this menu, you select the function for each connected speaker in your setup, such as front, back or surround. As you highlight each speaker, a sound is produced by the speaker. Check that the speaker type highlighted in the menu matches the speaker type making the sound. [See page 23](#) for further information.

SPEAKER DISTANCE ... In this menu, you select the distance in metres to each of the speakers in your setup. [See page 24](#) for further information.

SPEAKER LEVEL ... In this menu, you can adjust the volume level of each speaker in your setup. [See page 25](#) for further information.

SOUND ADJUSTMENT ... In this menu, you can adjust bass, volume, treble and loudness. In addition, you can preset two default speaker combinations; one for video sources and one for audio sources connected to your television. [See page 34](#) for further information.

**If you have a Beo4 without a navigation button or if your Beo4 is not set to the correct mode, you cannot enable the navigation button. See the Beo4 guide or contact your Bang & Olufsen retailer for further information. However, do not change mode during first-time setup, as this will interrupt the sequence.*

Adaptive Sound Technology enabled:

SPEAKER SETUP ... In this menu, you register the speaker type in the menu. Enter the straight-line distances from two points, Points A and B to each speaker, to the left and right sides of the television screen and a projector screen, to a viewing position and the distance between the two points. [See page 29](#) for further information.

TV ... Select the speakers to be active when you watch television and determine the distance from your listening position to three of the activated speakers. You can enable Adaptive Sound Technology or set the speaker roles and levels. [See page 30](#) for further information.

CINEMA ... Select the speakers to be active for a connected projector and determine the distance from your listening position to three of the activated speakers. You can enable Adaptive Sound Technology or set the speaker roles and levels. This menu is only available if you have connected a projector. [See page 30](#) for further information.

SOUND ADJUSTMENT ... In this menu you adjust volume, bass, treble, and loudness. In addition, you can select two default speaker combinations; one for video sources and one for audio sources connected to your television. You can also select which LISTENING PRESET should be activated when you switch on an audio source. If you select the option MANUAL, the preset used when switching on the audio source continues to be active and if all your sources are switched off, the preset used before switching on the audio source is automatically activated. If you select one of your LISTENING PRESETS, this preset is activated every time you switch on an audio source. [See page 34](#) for further information.

SOUND SETUP ... Enter the LISTENING PRESETS menu and select a PRESET field. Then select the speakers to be active for different listening positions, such as at the dining table or in a favourite armchair, and determine the distance from your listening position to three of the activated speakers. You can enable or disable the Adaptive Sound Technology and either rotate the selected speaker setup or set the speaker roles and level. [See page 30](#) for further information.

Continue first-time setup:

STAND ADJUSTMENT ... Set the maximum angle for turn and tilt of the television. Use ▲, ▼, ◀ and ▶ to tilt and turn the television and limit the movement of the stand. [See page 9](#) for further information.*

STAND POSITIONS ... Set your preferred preset positions for the television. For further information about the STAND POSITIONS menu, [see page 9](#).

STANDBY SETTINGS ... The television can be set to switch itself to standby after some time with no operation. You can also switch power saving on or off. [See page 42](#) for further information.

DVB SETUP ... If the DVB-HD tuner is enabled, the DVB SETUP menu appears, see the separate DVB-HD guide for further information.

If you have a Beo4 remote control without navigation button, or if the navigation button on your remote control is disabled, use the **green button to tilt the television up and the **red** button to tilt it down.*

For information about where and how to connect extra equipment, see the chapter about connection panels in Getting Started.

Choose menu language

The menu language you choose during the first-time setup of your television can be changed at any time.

Once a menu language is chosen, all menus and display messages are shown in this language.

You can select the language for on-screen menus via the TV SETUP menu. The text on the screen changes as you move from language to language.

- > Bring up the TV SETUP menu and highlight OPTIONS.
- > Press the **centre** button to bring up the OPTIONS menu and highlight MENU LANGUAGE.
- > Press the **centre** button to bring up the MENU LANGUAGE menu.
- > Highlight your language choice.
- > Press the **centre** button to make your choice.
- > Press **BACK** to back up through previous menus or press and hold **BACK** to leave the menus.

MENU LANGUAGE

DANSK
DEUTSCH
ENGLISH
ESPAÑOL
FRANÇAIS
ITALIANO
NEDERLANDS
SVENSKA

Set positions for the television to turn to

If your television is equipped with the optional motorised stand, you can tilt and turn it using the remote control.

Furthermore, you can program the television to tilt and turn automatically to face your favourite viewing position when you switch on the television. It can tilt and turn to a different position when you listen to, for example, a connected radio, and tilt or turn away to a standby position when you switch it off.

You can also turn your television by hand.

NOTE! For information about first-time installation of the motorised stand, see *Getting Started*.

Choose one position for when you switch the television on, one for audio mode, and one for when you switch it off.

- > Bring up the TV SETUP menu and highlight STAND POSITIONS.
- > Press the **centre** button to bring up the STAND POSITIONS menu.
- > Press the **centre** button to determine the VIDEO position.
- > Use **▲**, **▼**, **◀** and **▶** to tilt and turn the television and place it according to your viewing position.
- > Press the **centre** button to store the position.

To store a stand position for when an audio source is switched on from the television ...

- > Highlight AUDIO.
- > Press the **centre** button to determine the AUDIO position.
- > Use **▲**, **▼**, **◀** and **▶** to tilt and turn the television and place it as you wish.
- > Press the **centre** button to store the position.

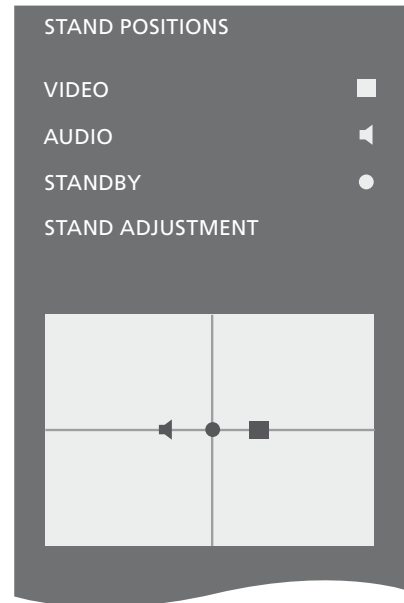

To store a stand position for when the television is switched off and in standby ...

- > Highlight STANDBY.
- > Press the **centre** button to determine the STANDBY position.
- > Use **▲**, **▼**, **◀** and **▶** to tilt and turn the television and place it as you wish.
- > Press the **centre** button to store the position.
- > During first-time setup, press the **green** button to continue first time-setup, or ...
- > ... press and hold **BACK** to leave all menus.

*If you have a Beo4 remote control without navigation button, or if the navigation button on your remote control is disabled, use the **green** button to tilt the television up and the **red** button to tilt it down.*

Tuner setup

If you disable the TV tuner or DVB tuner, you can activate a connected peripheral unit with the TV or DTV button.

To disable the internal tuner ...

- > Bring up the TV SETUP menu and highlight OPTIONS.
- > Press the **centre** button to bring up the OPTIONS menu, and highlight TUNER SETUP.
- > Press the **centre** button to bring up the TUNER SETUP menu and highlight TV TUNER.
- > Use the navigation button left or right to switch between the setting ON or OFF.
- > Highlight DVB.
- > Use the navigation button left or right to switch between the setting ON or OFF.
- > Press the **centre** button to store the settings, or ...
- > ... press and hold **BACK** to leave the menus without storing.

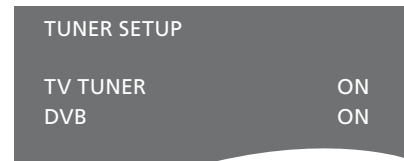

The TUNING menu is only available if the TV tuner is enabled. [See pages 18 and 21.](#)

If you have connected a Bang & Olufsen hard disk recorder to your TV, we recommend not to disable the TV tuner.

Connections

The connection panel on your television allows you to connect signal input cables as well as a variety of extra equipment, such as a video recorder or a linked Bang & Olufsen music system.

Any equipment you connect to these sockets must be registered in the CONNECTIONS menu. For further information, [see page 15](#).

Before you connect any equipment to your television, remember to disconnect the television from the mains.

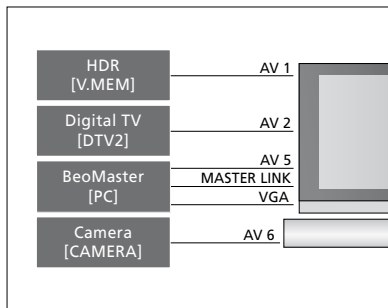
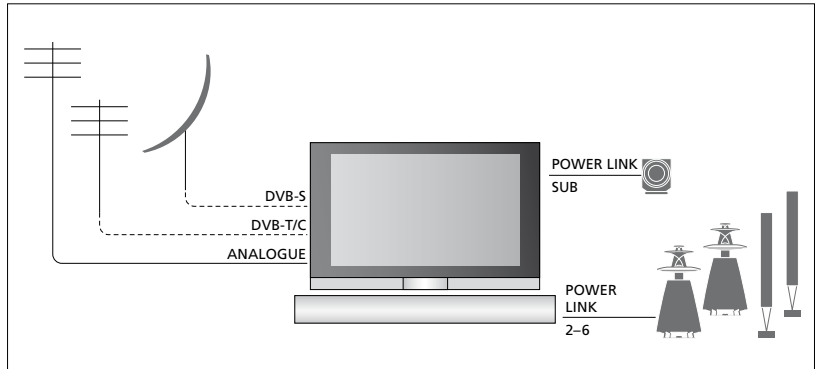

There are some restrictions as to the types of equipment that can be connected to the sockets.

Equipment with VGA output can only be connected and registered to the AV5 and AV6 sockets.

Loudspeakers

Use Bang & Olufsen Power Link speakers. Use the cables enclosed with the speakers. Cables are available from your Bang & Olufsen retailer.

Equipment with HDMI™ output

Equipment with HDMI output such as a set-top box can be connected to any available HDMI socket in the TV, regardless of the particular AV socket group to which you have connected the equipment. To distribute the source to another room you must also connect a CVBS video signal from the connected equipment to an AV socket on the connection panel. For further information on how to set up connected equipment for use, [see page 15](#).

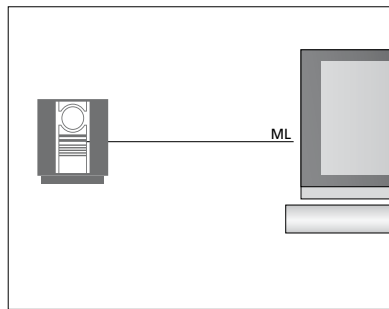
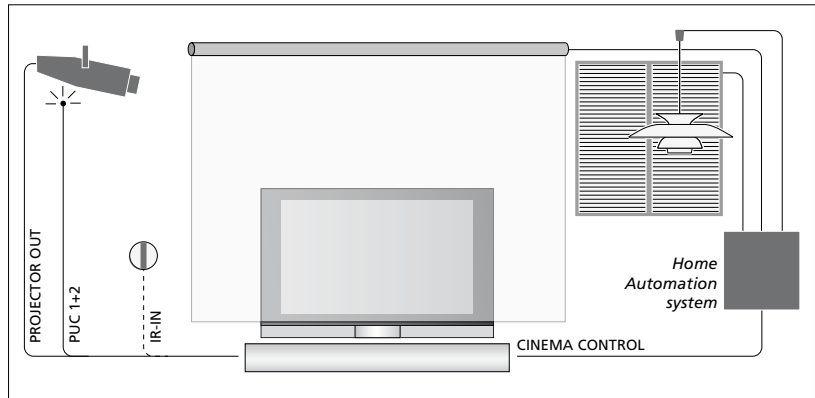

Home cinema setup with a projector and a home automation system

Use a projector or connect a home automation system to the TV so you can control room lights and curtains.

If the built-in receiver for the remote control signals (IR-receiver) is hidden behind the lowered projection screen, you must set up an external IR-receiver, as well. The IR-receiver is available as an optional accessory from your Bang & Olufsen retailer.

For further information about Home cinema, [see page 39](#).

Audio system

If you have a Bang & Olufsen audio system with a Master Link socket, you can connect it to your television. Use a Master Link cable, and connect it to the Master Link socket on the main connection panel. See Getting Started for further information.

Control

In the AV menus you can select how a PUC controlled product is connected. You can choose between PLUG (cable) and IR (IR Blaster). If you select PLUG, you must choose between MODULATION ON and MODULATION OFF. For information about type of cable and modulation settings, contact your retailer.

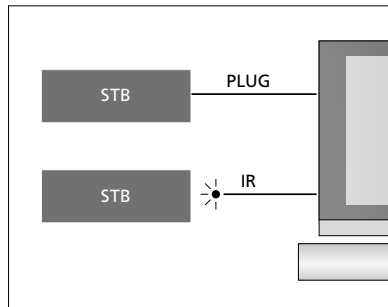

IR-transmitters: To operate non-Bang & Olufsen products with a Bang & Olufsen remote control, attach a Bang & Olufsen IR-transmitter to each of the products. Connect each transmitter to the corresponding socket marked PUC on the main connection panel.

DVB module

The CA module is a 'card reader' for your Smart Card which decodes the coded signals sent out by the programme provider.

You can insert a CONAX Smart Card directly into the built-in Smart Card Reader.

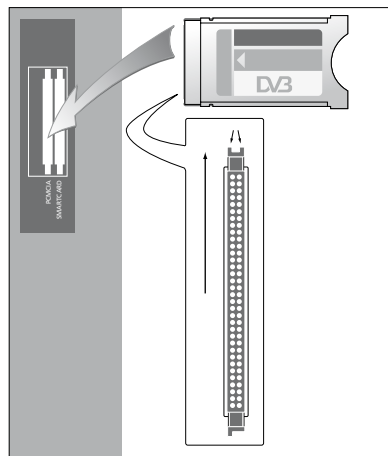

The CA module has one protruding edge on one side and two protruding edges on the other side. The side with two edges should face upwards.

When inserting a card, the gold chip should face away from the screen.

>> Connections

Connect and use a PC

IMPORTANT! Before connecting a PC to the television, disconnect the television, the computer, and all equipment connected to the computer from the mains.

To connect a computer to the television ...

- > Using the appropriate type of cable, connect one end to the VGA or HDMI output socket on your computer, and the other end to the VGA or HDMI socket on the television.
- > To hear sound from the computer in the speakers connected to the television, use the appropriate cable and connect the sound output on the computer to the L-R or SPDIF sockets on the television when appropriate.
- > Reconnect the television, the computer, and all equipment connected to the computer to the mains. Remember, the computer must be connected to a grounded wall outlet as specified in its setting-up instructions.

If you have connected your PC to the VGA socket on the television, you must register the PC to the AV5 or AV6 socket in the CONNECTIONS menu. A PC connected to the HDMI socket can be registered to any of the AV socket groups.

Bring up the computer image on the screen

To see the computer picture on the screen, you must bring it up with your remote control.

To bring up the computer picture ...

- > Press **PC** to bring up the picture. You can then operate the computer as you normally would. (Beo4: Press **LIST** and use the navigation button up or down to bring up **PC** in the Beo4 display and press the **centre** button to bring up the picture).

Watch digital pictures on your screen

To watch your camera pictures, connect the camera to the AV6 socket(s) and switch the television on. The television automatically registers the signal and you can see the pictures on the screen.

If the signal from the camera is switched off ...

- > Press **CAMERA** on Beo6. (Beo4: Press **LIST** and use the navigation button up or down to bring up **CAMERA** in the Beo4 display and press the **centre** button to bring up the picture).

Register additional video equipment

If you connect additional video equipment to your television, you must register the equipment in the CONNECTIONS menu.

When the television is first set up, some of the equipment connected at that particular moment is detected by the television. The CONNECTIONS menu appears automatically on the screen during first-time setup for you to register connected equipment, if it is not detected automatically by the television. If you connect equipment at a later date, you must register this equipment in the CONNECTIONS menu.

What is connected?

Registering the equipment connected to the television enables you to operate it with your remote control.

- > Bring up the TV SETUP menu and highlight OPTIONS.
- > Press the **centre** button to bring up the OPTIONS menu. CONNECTIONS is highlighted already.
- > Press the **centre** button to bring up the CONNECTIONS menu.
- > Use the navigation button up or down to step between the different socket groups: AV1, AV2, AV3, AV5, AV6, PROJECTOR OUT, HDMI EXPANDER and LINK.
- > Press the **centre** button to be able to register a connected product type to the highlighted socket group.
- > Use the navigation button up and down to move between the sockets in the group.
- > Use the navigation button left or right to register what you have connected to the highlighted socket.
- > Press the **centre** button **while** SOURCE is highlighted to be able to select the product from an on-screen list.
- > Use the navigation button left or right to see lists for other types of products.
- > Use the navigation button up or down or a number button to highlight the name of the product and press the **centre** button to register it.
- > Press the **green** button to be able to name the source. The naming menu is now activated.
- > Use the navigation button up and down to find the individual characters in the name.
- > Press the **centre** button to accept the name.

CONNECTIONS

AV1	NONE
AV2	NONE
AV3	NONE
AV4	NONE
AV5	NONE
AV6	NONE
PROJECTOR OUT	NONE
HDMI EXPANDER	NO
LINK	

The available sockets may vary according to your setup.

- > Names are shown in the television on-screen display when the source is selected.
- > Press the **centre** button to bring up the STANDBY OPTIONS menu.
- > Use the navigation button up or down to highlight a standby option for when the connected equipment should switch to standby. [See page 17.](#)
- > Press the **centre** button to select the highlighted standby option.
- > When you have completed your settings for a single socket group, press the **centre** button to return to the CONNECTIONS menu.
- > Repeat the procedure for each socket group.

*At first-time setup only, when you have registered all connected equipment, press the **green** button to store the setup.*

What's on the AV1 – AV6 menus ...

SOURCE ... Select the source you have connected. The option you select indicates which remote control button switches on the source. For example, a source registered as V.MEM is switched on when you press the **V.MEM** button. A source registered as DTV2 is switched on when you press **DTV2**. (Beo4: Press **LIST** and then the navigation button up or down to display **DTV2** and press the **centre** button). Options are:

NONE ... if nothing is connected.

V.MEM ... for a connected video recorder or hard disk recorder.

DVD ... for the optional Blu-ray player.

DVD2 ... for a connected DVD player or recorder.

DTV ... occupied by the optional DVB module, unless you disable the DVB tuner in the **TUNER SETUP** menu.

DTV2 ... for other equipment, such as a set-top box.

V.AUX2 ... for other equipment, such as a video game console.

TV ... occupied by the TV tuner, unless you disable the tuner in the **TUNER SETUP** menu.

PC ... for a connected PC.

CENTRE ... for connection of a source centre, which may contain up to six built-in sources, such as a DVD player and a set-top box. This option is only available in the AV1 and the AV2 menus.

NAME ... Allows you to name the source you are registering, the name you enter appears in the on-screen display when you activate the source.

AUTO SELECTION ... Allows connected sources to be selected automatically as soon as the television detects a signal, provided the television is on at the time. Options are YES and NO.

(TIMER RECORDER) ... Activate the Timer recording signal for a connected recorder. Options are YES and NO. Only available in the AV1 and AV2 menus, and can only be activated in one of these menus at any time.

HDMI ... Indicates whether or not the equipment is connected to the television via one of the HDMI sockets. Select the appropriate socket.

(SOUND INPUT) ... Indicates the sound signal used. This option is only available when the equipment is registered to an HDMI socket. Options are HDMI and S/P-DIF.

(YPbPr) ... Indicates whether or not the equipment is connected to the television via the YPbPr sockets. Options are YES and NO. Can only be registered in one of the AV menus (AV2 or AV3) at any time.

(AV3 -> AV1) ... Select whether the TV should route signals from AV3 to AV1, even when the TV is switched off. You can use this feature when you have connected an external TV tuner to AV3 and a video recorder to AV1. Options are: NO and AUTO. This option is only available in the AV3 menu.

(VGA) ... Indicates whether or not the equipment is connected to the television via the VGA socket. Options are YES and NO. Can only be registered in one of the AV menus (AV5 or AV6) at any time.

While it is possible to register equipment under any of the available source types, the type you select affects how you can use your source.

What's on the PROJECTOR OUT menu ...
Select the projector type.

What's on the HDMI EXPANDER menu ...
An HDMI Expander must always be connected to HDMI C, when present. When connecting an HDMI Expander, additional HDMI sockets become available; C1, C2, C3 and C4.

What's on the LINK menu ...
Set a link frequency and enable the system modulator.

AV2	
SOURCE NAME	NONE
AUTO SELECTION	NO
TIMER RECORDER	NO
HDMI	NO
SOUND INPUT Y/Pb/Pr	NO

Regarding High Definition (HD) sources ...

Standard Definition (SD) signals can be recorded, as well as distributed to a link room television, but HD signals cannot.

If you watch a DVD or Blu-ray disc in your main room and you select the same source in your link room, the signal will change to standard definition on both televisions.

Connect both the HD and the SD signals to the television. The best signal is always used. If no HD signal is available, the SD signal is shown.

Standby options ...

When you register a non-Bang & Olufsen product in the CONNECTIONS menu, you can also select different STANDBY OPTIONS for your product. This means that you can select if the connected product should switch to standby automatically.

The options are:

OFF AT SOURCE CHANGE ... The product switches to standby immediately when you select another source.

OFF AT TV STANDBY ... The product switches to standby when you switch the television to standby.

ALWAYS ON ... The television does not switch the product to standby, but the product may switch to standby due to its own settings.

MANUAL CONTROL ... The product can only be switched on and off by means of the remote control. For further information [see page 56.](#)

Edit tuned TV channels

If automatic tuning of all channels has not stored the channels on your preferred channel numbers or has not named all the stored channels automatically, you can rearrange the order in which the channels appear and provide them with a name of your own choice.

If the tuned channels require additional editing, such as fine tuning, use the MANUAL TUNING menu, [see page 20](#).

For tuning of your digital channels, see the guide for the DVB module.

Move, name or delete tuned TV channels

Once automatic tuning of channels has been completed, the EDIT CHANNELS menu appears automatically and you can move or name the TV channels that have been tuned in. You can also delete any tuned TV channel you do not want.

Enter the EDIT CHANNELS menu ...

- > Bring up the TV SETUP menu and highlight TUNING.
- > Press the **centre** button to bring up the TUNING menu and highlight EDIT CHANNELS.
- > Press the **centre** button to bring up the EDIT CHANNELS menu.

Move tuned TV channels ...

- > In the EDIT CHANNELS menu, highlight the channel you wish to move.
- > Use the navigation button right to move the channel out of the list.
- > Use the navigation button up or down to move the channel to the desired channel number.
- > Use the navigation button left to move the channel back into the list or change places with the channel which occupies the desired channel number.
- > Now, move the channel which you changed places with to an empty channel number or to a number already occupied and repeat the procedure.
- > When you have moved the relevant channels, press **BACK** to back up through menus, or press and hold **BACK** to exit all menus.

>> *Edit tuned TV channels*

Name tuned channels ...

- > In the EDIT CHANNELS menu highlight the channel you wish to name.
- > Press the **green** button to be able to name the channel. The naming menu is now activated.
- > Use the navigation button up and down to find the individual characters in the name.
- > Move between character places with the navigation button left or right.
- > Press the **centre** button to store the name.
- > If necessary, repeat the procedure and name other channel numbers.
- > When you have named the relevant channels, press the **centre** button to accept your edited list, or press and hold **BACK** to exit all menus without storing.

Delete tuned channels ...

- > In the EDIT CHANNELS menu highlight the channel you wish to delete.
- > Use the navigation button right to move the channel out of the list.
- > Press the **yellow** button to be able to delete the channel.
- > Press the **yellow** button again to confirm the deletion, or press the navigation button left twice to move the channel back into the list.
- > When you have deleted the relevant channels, press and hold **BACK** to exit all menus.



Move a channel.

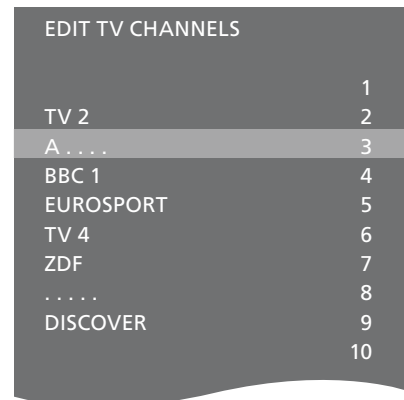

Name a channel.

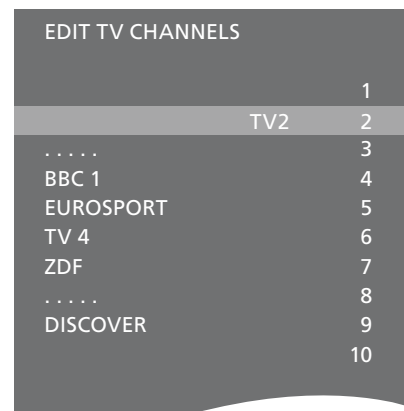

Delete a channel.

Adjust tuned channels

You can store TV channels on channel numbers of their own. Fine tune the channel reception, indicate the presence of coded channels and choose appropriate sound types for the individual channels.

- > Bring up the TV SETUP menu and highlight TUNING.
- > Press the **centre** button to bring up the TUNING menu and highlight MANUAL TUNING.
- > Press the **centre** button to bring up the TV MANUAL TUNING menu.
- > Use the navigation button up and down to move between the items in the menu.
- > Use the navigation button left and right to view your choices for each item.
- > If you choose NAME, then press the **green** button to start the naming procedure. Use the navigation button up and down to enter the characters in the name you choose. Use the navigation button left and right to move between the characters in the name.
- > To bring up the extra TV MANUAL TUNING menu, move to EXTRA and press the **centre** button. Now fine tune if relevant, or select type of sound.
- > When you have finished editing, press the **centre** button to accept the settings.
- > Press the **centre** button to store the adjusted channel.
- > Press and hold **BACK** to exit all menus.

If the item TV SYSTEM appears on the menu, then make sure that the correct broadcast system is displayed before you begin tuning:

B/G ... for PAL/SECAM BG
 I ... for PAL I
 L ... for SECAM L
 M ... for NTSC M
 D/K ... for PAL/SECAM D/K

If channels are broadcasted with two languages and you want both languages, you can store the channel twice, once with each language.

What's on the TV MANUAL TUNING menu ...

SEARCH ... Start search tuning.
 FREQUENCY ... Select a frequency to tune in.
 CHANNEL NUMBER ... Store or change channel number. You can store 99 channels.
 NAME ... Access the naming menu and name the channel you have selected.
 EXTRA ... Access the extra TV MANUAL TUNING menu.

What's on the extra TV MANUAL TUNING menu ...

FINE TUNE ... Fine tune the frequency of a channel or tuned channel. You can fine tune within the range of -8 – +8.
 (DECODER) ... A decoder is necessary for the reception of coded channels. Usually the decoder is detected automatically during tuning, but it can be selected via this menu option. Set DECODER to one of following options: ON (for decoder on) or OFF (for no decoder).
 (TV SYSTEM) ... TV broadcast system – this option is only available on certain types of TV sets, as the TV broadcast system is usually selected automatically.

TV MANUAL TUNING

SEARCH	...
FREQUENCY	217
CHANNEL NO.	7
NAME	DR 1
FINE TUNE	0
DECODER	OFF
TV SYSTEM	PAL/BG
SOUND	STEREO

SOUND (mono, stereo or language) ...

Several types of sound may be available for different channels, mono, stereo or different languages. On the relevant channel or frequency select the options MONO (FM / NICAM mono sound), STEREO (NICAM / A2 stereo sound), MONO1 (mono language 1), MONO2 (mono language 2), MONO3 (mono language 3), or STEREO2 (stereo language 2).

Even though you store a type of sound/ language, you can switch between the various types while watching a TV programme. For further information see Getting Started.

Re-tune or add channels

You can make your television find your TV channels for you.

Preset up to 99 different TV channels on channel numbers of their own and give each channel a distinct name.

You can tune in new channels, for example, if you move – or re-tune previously deleted channels.

When tuning in channels via the ADD CHANNEL menu, your previously tuned channels are left unchanged. This allows you to keep channel names, their order in the TV list, and any special settings you may have stored for those channels.

You can re-tune all your TV channels by letting the television tune in all the channels automatically. You can also add a new channel or update a tuned channel which, for example, has been moved by the broadcaster.

- > Bring up the SETUP menu and highlight TUNING.
- > Press the **centre** button to bring up the TUNING menu.

Re-tune via automatic tuning ...

- > In the TUNING menu highlight AUTO TUNING.
- > Press the **centre** button to bring up the AUTO TUNING menu.
- > Use the navigation button right to start auto tuning.
- > Once auto tuning is completed, the EDIT CHANNELS menu appears. You can then remove or name channels.

Add new TV channels ...

- > In the TUNING menu highlight ADD CHANNEL.
- > Press the **centre** button to bring up the ADD CHANNEL menu.
- > Use the navigation button right to start. New channels are added automatically as they are found.
- > When tuning is completed and new channels have been added, the EDIT CHANNELS menu appears. You can then remove or name channels. The cursor highlights the first new channel just added to the list.

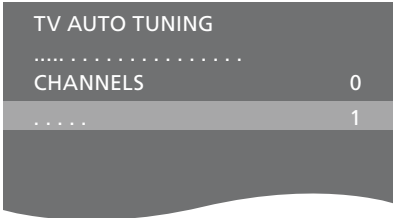

A screenshot of a television menu titled "TV AUTO TUNING". It shows a list of channels with their corresponding numbers. The channel "CHANNELS" is highlighted with a grey bar and has the number "1" next to it. Other channels listed include "0" and "1".

Channel Name	Channel Number
.....	0
CHANNELS	0
.....	1
.....	1

NOTE! If you re-tune all your TV channels, all the channel settings you have made disappear!

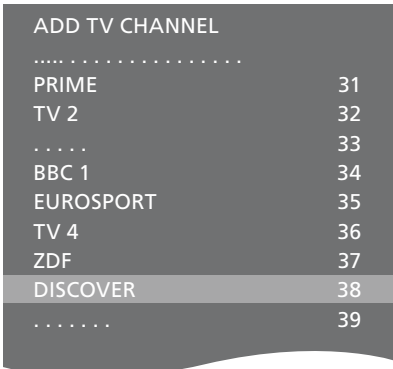

A screenshot of a television menu titled "ADD TV CHANNEL". It shows a list of channels with their corresponding numbers. The channel "DISCOVER" is highlighted with a grey bar and has the number "38" next to it. Other channels listed include "PRIME" (31), "TV 2" (32), "BBC 1" (34), "EUROSPORT" (35), "TV 4" (36), "ZDF" (37), and "39".

Channel Name	Channel Number
.....	31
PRIME	31
TV 2	32
.....	33
BBC 1	34
EUROSPORT	35
TV 4	36
ZDF	37
DISCOVER	38
.....	39

Loudspeaker setup – surround sound

Add Power Link speakers and a BeoLab subwoofer to your television and you have a surround sound system.

A surround sound setup fits easily into your living room. Let the picture determine your ideal viewing and listening position. You get the best sound experience in the area created by the speakers.

If you have several speakers and a Beo6 remote control, you can enjoy the advantages of Adaptive Sound Technology instead of the setup described in this chapter. [See page 27.](#)

Select your speaker types

Switch on the television in TV or Home cinema mode before you adjust speaker settings.

To register the speaker types ...

- > Bring up the TV SETUP menu and highlight OPTIONS.
- > Press the **centre** button to bring up the OPTIONS menu and highlight SOUND.
- > Press the **centre** button to bring up the SOUND SETUP menu and highlight SPEAKER TYPE.
- > Press the **centre** button to bring up the SPEAKER TYPE menu and Use the navigation button left or right to reveal your centre speaker type.
- > Highlight CONFIG. This allows you to select a CENTRE configuration as a single speaker or a pair. Depending on which centre speaker or speakers you select, CONFIG may be greyed out and inaccessible.
- > Press the navigation button down to move to the next speaker and press use the navigation button left or right to reveal your speaker type.
- > Press the **centre** button to store or press **BACK** to leave the menu without storing.

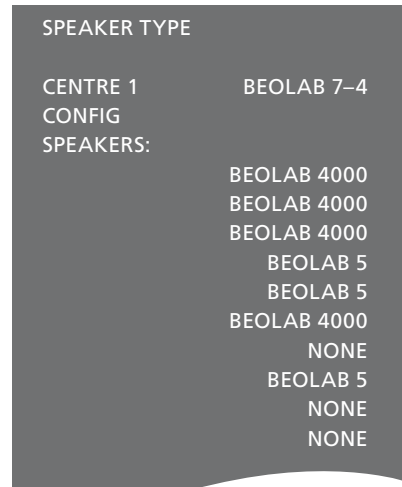

Assign roles to speakers

The speakers you connect to the television can have more than one role. If, for example, you only use one set of front speakers when you watch TV on your television screen, you can turn your chair ninety degrees towards a projector screen and use those same speakers as right front and rear speakers in a surround sound system for Home cinema.

To assign roles to speakers ...

- > Bring up the TV SETUP menu and highlight OPTIONS.
- > Press the **centre** button to bring up the OPTIONS menu and highlight SOUND.
- > Press the **centre** button to bring up the SOUND SETUP menu and highlight SPEAKER ROLES.
- > Press the **centre** button to bring up the SPEAKER ROLES menu.
- > Highlight a speaker role. When you highlight a speaker role, a sound is produced by a speaker.
- > Use the navigation button left or right to select a role for the speaker producing the sound.
- > Repeat the procedure for each speaker.
- > Press the **centre** button to store or press and hold **BACK** to leave the menu without storing.

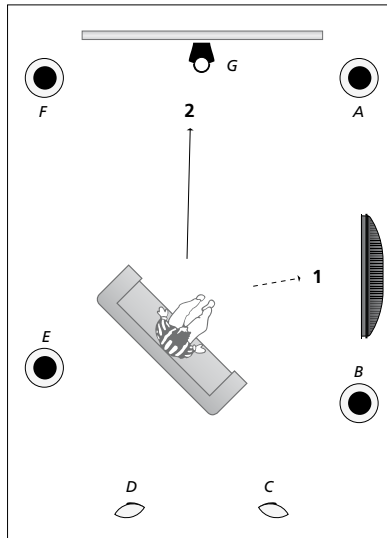

Assigning roles to the connected loudspeakers allows you to specify the speakers' function in a surround sound system and the number of speakers to be used. Assign different roles for watching TV (1) and Home cinema (2), as shown in the illustration:

TV viewing (1) ...

Speaker A:	Left front
Speaker B:	Right front
Speaker C:	Off
Speaker D:	Off
Speaker E:	Right surround
Speaker F:	Left surround
Speaker G:	Off

Home cinema viewing (2) ...

Speaker A:	Right front
Speaker B:	Right surround
Speaker C:	Right back
Speaker D:	Left back
Speaker E:	Left surround
Speaker F:	Left front
Speaker G:	Centre

TV SPEAKER ROLES

SPEAKERS:

	NONE
	NONE
	NONE
RIGHT SURROUND	
RIGHT FRONT	
	NONE
	NONE
LEFT SURROUND	
LEFT FRONT	
	NONE
	NONE
	NONE

What's on the TV SPEAKER ROLES menu ...

Options are NONE, LEFT FRONT, RIGHT FRONT, LEFT SURROUND, RIGHT SURROUND, LEFT BACK, RIGHT BACK, CENTRE BACK.

What's on the CINEMA SPEAKER ROLES menu ...

Options are NONE, LEFT FRONT, RIGHT FRONT, LEFT SURROUND, RIGHT SURROUND, LEFT BACK, RIGHT BACK, CENTRE BACK, CENTRE, LEFT CENTRE, RIGHT CENTRE.

You must select the surround speakers before you can select the back speakers.

Set speaker distance

Switch on the television from your favourite viewing position. Enter the straight-line distances in metres between your position and the individual speakers.

To set the speaker distances ...

- > Bring up the TV SETUP menu and highlight OPTIONS.
- > Press the **centre** button to bring up the OPTIONS menu and highlight SOUND.
- > Press the **centre** button to bring up the SOUND SETUP menu and highlight SPEAKER DISTANCE.
- > Press the **centre** button to bring up the SPEAKER DISTANCE menu.
- > Move the cursor from speaker to speaker and use the navigation button left or right to select the approximate straight-line distance in metres between your viewing position and each of the speakers.
- > When you have entered the appropriate speaker distances, press the **centre** button to store or press **BACK** to leave the menu without storing.

SPEAKER DISTANCE

CENTRE	1.0 M
LEFT FRONT	1.0 M
RIGHT FRONT	1.0 M
LEFT SURROUND	1.0 M
RIGHT SURROUND	1.0 M
LEFT BACK	1.0 M
RIGHT BACK	1.0 M

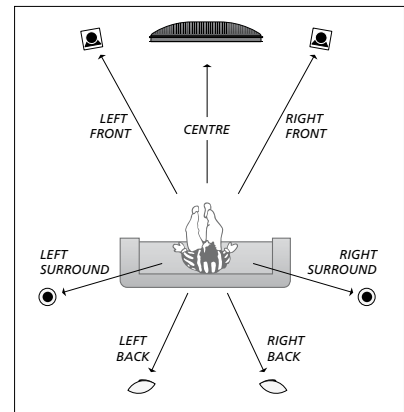

Calibrate the sound level

When you have connected speakers in a surround sound setup to the television, you must perform a speaker calibration.

A calibration sound is produced alternately in each of the speakers you have connected in your surround sound setup. Your task is to adjust the sound level from all the connected speakers to match the sound level from the centre speaker. You can choose whether you want the sound sequence to occur automatically or manually.

Once you have performed your speaker calibration, you will only need to re-calibrate the speaker sound if you make changes to the setup, for example, if you move one or more of the speakers.

To calibrate the sound level ...

- > Bring up the TV SETUP menu and highlight OPTIONS.
- > Press the **centre** button to bring up the OPTIONS menu and highlight SOUND.
- > Press the **centre** button to bring up the SOUND SETUP menu and highlight SPEAKER LEVEL.
- > Press the **centre** button to bring up the SPEAKER LEVEL menu. SEQUENCE is highlighted.
- > Use the navigation button left or right to choose between AUTOMATIC and MANUAL.
- > Use the navigation button left or right to adjust the speaker sound and use the navigation button up or down to move to another speaker.
- > When you have adjusted the sound for all the speakers in your surround sound setup, press the **centre** button to store or press **BACK** to leave the menu without storing.

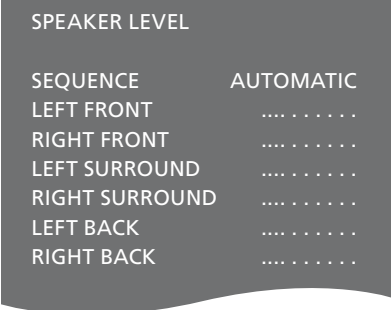

SPEAKER LEVEL	
SEQUENCE	AUTOMATIC
LEFT FRONT
RIGHT FRONT
LEFT SURROUND
RIGHT SURROUND
LEFT BACK
RIGHT BACK

See the name of the active sound system

You can see the name of the active sound system for a source or programme on the screen. However, it is not possible to adjust or preset a sound system.

To see the active sound system ...

- > Bring up the TV SETUP menu and highlight OPTIONS.
- > Press the **centre** button to bring up the OPTIONS menu and highlight SOUND.
- > Press the **centre** button to bring up the SOUND SETUP menu and highlight SOUND SYSTEM.
- > Press the **centre** button to bring up the SOUND SYSTEM menu. The active sound system is shown.
- > Press and hold **BACK** to exit all menus.

SOUND SYSTEM

INPUT FORMAT:
MONO/STEREO

OUTPUT FORMAT:
STEREO
SPEAKER 1

ADAPTIVE SOUND
TECHNOLOGY:
DISABLED

LISTENING PRESET:

An example of a sound system that can appear in the menu.

Your speaker combination does not need to match the number of available channels for the sound system to be in effect.

Adaptive Sound Technology

Your system is equipped with Adaptive Sound Technology which allows you to enjoy an optimal sound experience with a multiple speaker setup even though your speakers are not placed correctly for your listening position. The Adaptive Sound Technology feature in the television uses all connected speakers to create the ultimate sound experience of perfectly placed speakers.

To enjoy the advantages of this setup, several speakers and a Beo6 remote control are necessary. If you have only a few speakers or a Beo4 remote control, this setup is not recommended and you should choose the setup without Adaptive Sound Technology described in the chapters about first-time setup and loudspeaker setup on [pages 6 and 22](#).

In this part of the setup you set up speakers for your television and an optional projector.

For information about daily use of Adaptive Sound Technology, see Getting Started.

Enable Adaptive Sound Technology

If you choose to switch on the Adaptive Sound Technology function, you can still disable it in one or more of the listening presets you make.

- > Bring up the TV SETUP menu and highlight OPTIONS.
- > Press the **centre** button to bring up the OPTIONS menu and highlight SOUND.
- > Press the **centre** button to bring up the SOUND SETUP menu and highlight AST ON/OFF.
- > Press the **centre** button to bring up the AST ON/OFF menu.
- > Use the navigation button left or right to enable or disable the technology.
- > Press the **centre** button to store or press and hold **BACK** to leave the menu without storing.

In the SOUND SYSTEM menu you can see whether the Adaptive Sound Technology is enabled or not and which listening preset is currently activated. [See page 26](#).



Points A and B

For Adaptive Sound Technology to figure out the exact position of each speaker, you will need to decide on two fixed points, Point A and Point B, before you can enter the settings of the speaker setup menu. These points could, for example, be on a wall.

Guidelines for fixing Point A and Point B:

- 1 Fix the points in the edge of a room, so all speakers are placed on the same side of an imaginary line between Point A and Point B.
- 2 Fix the points far apart from each other, at least two metres.
- 3 From both Point A and Point B you should be able to see all speakers in the setup. However, it is acceptable if a piece of furniture is in the way.

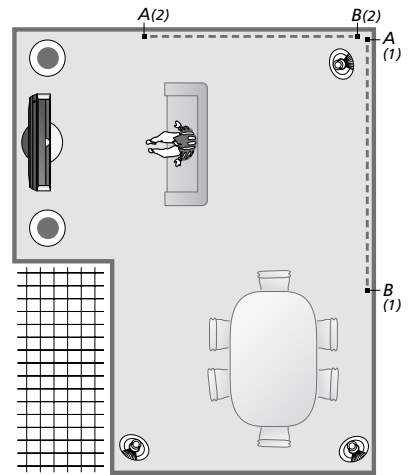

Examples of two possibilities for points A and B with the imaginary line from one point to the other. You can preset speaker combinations for several listening positions such as at the sofa when you watch television, at the dining table or when you sit in an armchair reading.

Set up the speakers

Set the speaker types and the distances from Points A and B to each speaker, to the left and right side of the television screen and a projector screen, to a viewing position and the distance between the two points.

Set speaker type and distance ...

- > Bring up the TV SETUP menu and highlight OPTIONS.
- > Press the **centre** button to bring up the OPTIONS menu and highlight SOUND.
- > Press the **centre** button to bring up the SOUND SETUP menu and highlight SPEAKER SETUP.
- > Press the **centre** button to bring up the SPEAKER SETUP menu.
- > Use the navigation button left or right to select the speaker types.
- > Press the **centre** button to store the settings and bring up the DISTANCE TO POINT A menu.
- > Enter the required horizontal distances in metres. The distance to a stereo speaker should be measured to the left and right edges of the speaker.
- > Press the **centre** button to store the settings and bring up the DISTANCE TO POINT B menu.
- > Enter the horizontal distances.
- > Press the **centre** button to store the setting. The television can now calculate your speaker setup.

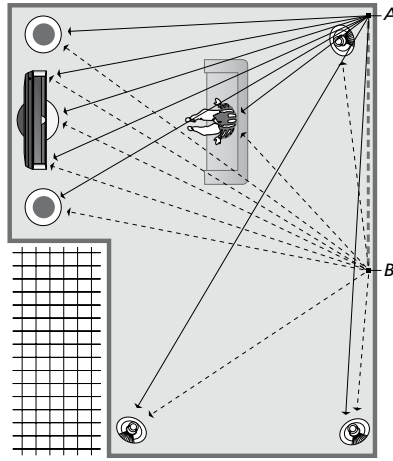

Select the viewing position from where you watch television.

When you set the speaker type, the speaker name highlighted in the menu should match the speaker producing a sound. In the menu that follows, you are asked to enter the horizontal distance in metres from Point A to each of your speakers, to the left and right edge of your television screen and a connected projector screen, to a viewing position and to Point B.

SPEAKER TYPE

CENTRE 1	BEOLAB 7-2
CONFIG	
SPEAKERS:	
	BEOLAB 5
	BEOLAB 5
	BEOLAB 9
	BEOLAB 9
	BEOLAB 4000
	BEOLAB 4000
	BEOLAB 4000
	BEOLAB 4000
	BEOLAB 4000
	NONE
	NONE
	NONE
	NONE

DISTANCE TO POINT A

BEOLAB 7-2 LEFT	1.0 M
BEOLAB 7-2 RIGHT	1.0 M
BEOLAB 5	1.0 M
BEOLAB 5	1.0 M
BEOLAB 9	1.0 M
BEOLAB 9	1.0 M
BEOLAB 4000	1.0 M
BEOLAB 4000	1.0 M
BEOLAB 4000	1.0 M
BEOLAB 4000	1.0 M
BEOLAB 4000	1.0 M
BEOLAB 4000	1.0 M
TV LEFT	1.0 M
TV RIGHT	1.0 M
VIEW POSITION	1.0 M
CINEMA LEFT	1.0 M
CINEMA RIGHT	1.0 M
POINT B	1.0 M

Listening presets

Select the speakers to be activated in TV mode and, if you have connected a projector, in Cinema mode. You can also make up to five customised listening presets, such as at the dining table or in a favourite armchair. Select three to seven* speakers and up to two subwoofers to be activated for a preset and determine the distance from your listening position to three of the activated speakers.

For each customised listening preset it is also possible to rotate the perceived sound 360 degrees around the listening position. The default rotation is 0 degrees which is the direction from your listening position to the television.

If your speakers are placed correctly for your listening positions, it is recommended that you disable Adaptive Sound Technology and set the speaker roles, distances and levels. If you activate fewer than three speakers, it is not possible to enable the Adaptive Sound Technology and you must set the speaker roles, distances and levels. For further information about speaker roles, distances and levels, [see pages 23–25](#).

*A stereo speaker such as a BeoLab 7-1 or 7-2 counts as two speakers if fewer than six speakers are activated.

The distance from your listening position to any speaker in a listening preset should not exceed 10 metres.

To set speaker presets ...

- > Bring up the TV SETUP menu and highlight OPTIONS.
- > Press the **centre** button to bring up the OPTIONS menu and highlight SOUND.
- > Press the **centre** button to bring up the SOUND SETUP menu and highlight LISTENING PRESETS.
- > Press the **centre** button to bring up the LISTENING PRESETS menu and highlight TV, CINEMA or a custom preset field.
- > Press the **centre** button to bring up the highlighted menu.
- > Use the navigation button left or right to enable or disable the Adaptive Sound Technology.
- > Use the navigation button left or right to activate the preferred speakers. Three to seven speakers as well as up to two subwoofers can be activated.
- > Check that the Adaptive Sound Technology is enabled or disabled as you desire.
- > Press the **centre** button to store and bring up the next menu. If you have selected OFF to disable the Adaptive Sound Technology, [see pages 23–25](#) about how to assign roles to speakers, set the speaker distances and calibrate the sound level.
- > Enter the horizontal distance in metres between your listening position and each speaker making a sound.
- > If you are setting a customised preset and ADAPTIVE SOUND TECHNOLOGY is enabled, highlight ROTATION and select how much the sound stage should be rotated. A sound will be produced from the setup if a source is playing and you rotate until the sound is experienced from the desired direction.
- > Press the **centre** button to store and return to the LISTENING PRESETS menu. During first-time setup, press the **green** button to continue the first-time setup procedure when you have created the desired presets.

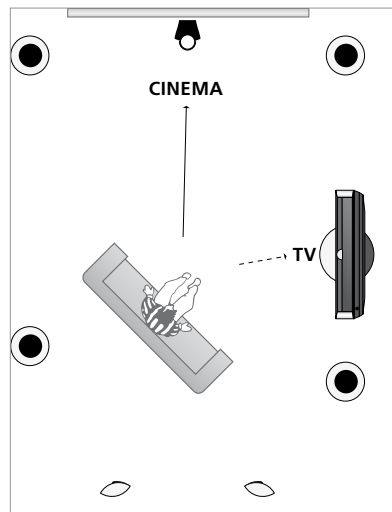

Example of a listening position for watching television and Home cinema. You select which speakers should be active for each situation.



*If you have changed the rotation of a preset during daily use, you can easily create a new preset with these settings. Enter the LISTENING PRESETS menu, select an empty PRESET field and press the **centre** button for each menu, as the current settings will automatically be applied to each of these menus.*

You can make the television switch to a customised listening preset automatically when an audio source is selected. [See page 34](#) about sound adjustment.

Name a customised preset

You can name your customised listening presets in the television menu yourself. Your retailer can help you name the customised listening presets in the Beo6 display.

To name a customised preset ...

- > Bring up the TV SETUP menu and highlight OPTIONS.
- > Press the **centre** button to bring up the OPTIONS menu and highlight SOUND.
- > Press the **centre** button to bring up the SOUND SETUP menu and highlight LISTENING PRESETS.
- > Press the **centre** button to bring up the LISTENING PRESET menu.
- > Highlight a desired customised listening preset and press the **green** button to be able to name the preset.
- > Enter a preferred name and store it by pressing the **centre** button on your remote control.

Delete a customised preset

You can delete any customised listening preset you do not want.

To delete a customised preset ...

- > Bring up the TV SETUP menu and highlight OPTIONS.
- > Press the **centre** button to bring up the OPTIONS menu and highlight SOUND.
- > Press the **centre** button to bring up the SOUND SETUP menu and highlight LISTENING PRESETS.
- > Press the **centre** button to bring up the LISTENING PRESET menu.
- > Highlight a desired customised listening preset and press the **yellow** button to be able to delete the preset – the preset is then dimmed.
- > Press the **yellow** button again to finally delete the preset.

Adjust picture and sound settings

Picture and sound settings are preset from the factory to neutral values which suit most viewing and listening situations. However, if you wish, you can adjust these settings to your liking.

Adjust picture brightness, contrast or colour. Sound settings include volume, bass and treble.

Store your picture and sound settings temporarily – until your television is switched off – or store them permanently.

Activate GAME MODE if you connect a game console to your television.

For information about how to change the picture format, see Getting Started.

Adjust brightness, colour or contrast

Adjust the picture settings via the PICTURE menu. Temporary settings are cancelled when you switch off the television.

- > Bring up the TV SETUP menu and highlight OPTIONS.
- > Press the **centre** button to bring up the OPTIONS menu and highlight PICTURE.
- > Press the **centre** button to bring up the PICTURE menu.
- > Use the navigation button up or down to move through menu items.
- > Use the navigation button left or right to adjust the values.
- > Press **BACK** to store your settings until you switch off the television, or
- > ... press the **centre** button to store your settings permanently.

For video sources using the VGA signal, the following options appear as well:

- HOR. SIZE ... Adjusts the picture size along the horizontal axis.
- VERT. SIZE ... Adjusts the picture size along the vertical axis.
- HOR. POSITION ... Adjusts the picture position along the horizontal axis.
- VERT. POSITION ... Adjusts the picture position along the vertical axis.

Note that these four settings only apply for the screen resolution in effect at the time you adjust the settings.

*To temporarily remove the picture from the screen, press \triangle to bring up the Scene display on Beo6, press **Picture**, then press **P.Mute**. To restore the picture, press **P.Mute** again. (Beo4: press **LIST** and use the navigation button up or down to bring up **P.MUTE** in the Beo4 display and press the **centre** button. To restore the picture, press a source button.)*

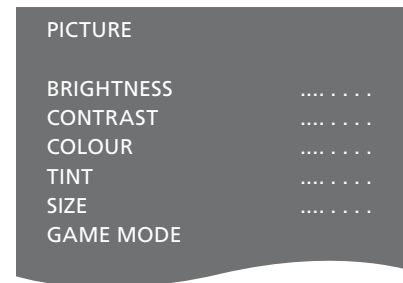

When signals are sent in format 1080p or 1080i, the menu item SIZE is available in the PICTURE menu.

For video sources using the NTSC signal, the menu item TINT is available.

You cannot adjust brightness or contrast when using a projector connected to the television, or when using the television in Home cinema mode.

Game mode

If you connect a game console or play a PC game using the television as a monitor, you can activate 'Game mode'. Game mode minimises the delay caused by signal processing. The television remembers if Game mode was activated the last time each source was selected.

To activate GAME MODE with Beo6 directly ...

> Press **Game** to activate Game mode, press again to deactivate Game mode.

*To activate GAME MODE with Beo4 directly*¹ ...*

> Press **LIST** and use the navigation button up or down to bring up **GAME** in the Beo4 display.
> Press the **centre** button repeatedly to switch between ON and OFF.

¹* *If you have a Beo4 without navigation button, GAME may not be available.*

To activate GAME MODE via the TV SETUP menu ...

> Bring up the TV SETUP menu and highlight **OPTIONS**.
> Press the **centre** button to bring up the **OPTIONS** menu and highlight **PICTURE**.
> Press the **centre** button to bring up the **PICTURE** menu.
> Use the navigation button up or down to move to **GAME MODE**.
> Press the **centre** button repeatedly to switch between ON and OFF.

Adjust volume, bass or treble

Sound settings are preset at the factory to neutral values which suit most listening situations. However, if you wish, you can adjust these settings to your liking.

You can preset levels for sound volume, bass, treble and up to two connected BeoLab subwoofers.

You can switch the loudness feature on or off. The loudness feature compensates for the human ear's lack of sensitivity to high and low frequencies. These frequencies are boosted at low volume levels so that low music becomes more dynamic.

In addition, you can select two default speaker combinations; one to be used each time you switch on a video source in your television, and one to be used each time you switch on an audio source connected to your television. You can still select a different speaker combination any time you wish.

When Adaptive Sound Technology is enabled and a customised listening preset is created, you can select an audio preset to be activated automatically when you switch to an audio source. The default audio setting determines which speakers in the selected audio preset should be activated.

For further information about speaker combinations, [see page 37](#).

To adjust sound ...

- > Bring up the TV SETUP menu and highlight OPTIONS.
- > Press the **centre** button to bring up the OPTIONS menu and highlight SOUND.
- > Press the **centre** button to bring up the SOUND SETUP menu, and highlight ADJUSTMENT.
- > Press the **centre** button to bring up the SOUND ADJUSTMENT menu.
- > Use the navigation button up or down to select an item to adjust.
- > Use the navigation button left or right to adjust the values or choose a setting.
- > Press **BACK** to store your settings until you switch off your television, or ...
- > ... press the **centre** button to store your settings permanently.

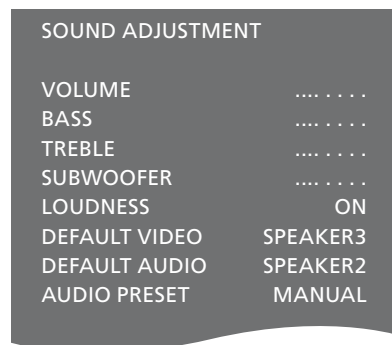

The content of the SOUND menu varies according to what you have connected to the television.

AUDIO PRESET is only available if Adaptive Sound Technology is enabled in the SOUND SETUP menu and you have created one or more customised listening presets. See [pages 27 and 30](#).

Set up 3D television

You can set up preferences for watching 3D television, such as selecting if the television should automatically switch to 3D mode, when automatic 3D signalling is available.

In addition, you can adjust the sharpness of the picture.

If your TV is equipped with the optional Blu-ray player, you can also use it to play 3D Blu-ray discs.

Activate 3D and adjust settings

You can select if the television should activate 3D mode automatically, manually or by prompt, when it detects automatic 3D signalling the first time after source or channel change. The default setting is **AUTO**.

To activate 3D ...

- > Bring up the TV SETUP menu and highlight 3D DISPLAY.
- > Press the **centre** button to bring up the 3D DISPLAY menu and highlight 3D SETTINGS.
- > Press the **centre** button to bring up the 3D SETTINGS menu, and highlight ACTIVATE 3D.
- > Use the navigation button left or right to select **AUTO**, **PROMPT** or **MANUAL**.
- > Press the **centre** button to store, or ...
- > ... press and hold **BACK** to leave the menu without storing.

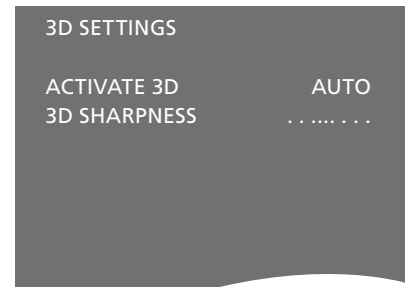

*When automatic 3D signalling is available, the television switches to 3D mode automatically if **ACTIVATE 3D** is set to **AUTO**. If it is set to **PROMPT**, you must select between **VIEW IN 3D** and **VIEW IN 2D**. If it is set to **MANUAL**, you must enter the menu and switch to 3D mode manually.*

>> *Set up 3D television*

You can fine tune the 3D experience and remove shadows to make the picture perfectly sharp. This menu is greyed out if you are not in one of the 3D modes or if you are in CINEMA mode.

To adjust 3D sharpness ...

- > Bring up the TV SETUP menu and highlight 3D DISPLAY.
- > Press the **centre** button to bring up the 3D DISPLAY menu and highlight 3D SETTINGS.
- > Press the **centre** button to bring up the 3D SETTINGS menu, and highlight 3D SHARPNESS.
- > Use the navigation button left and right to adjust the sharpness.
- > Press the **centre** button to store, or ...
- > ... press and hold **BACK** to leave the menu without storing.

Daily use of speaker combinations



You can extend your television into a surround sound system by adding Bang & Olufsen loudspeakers and up to two BeoLab subwoofers.

When you switch on one of the sources, the television automatically selects the appropriate speakers, depending on what kind of sound suits the source you are using.

The speaker combination is optimised if you press the **Optimise** button on Beo6. **NOTE!** If you have added only two front speakers to the TV, you will only be able to choose Mode 1–3.

Select speakers for movie sound

You can select the speaker combination that suits the source you are using, provided that the various speaker modes are available in your television.

- > Press  to bring up the Scene display on Beo6, then press **Speaker** to bring up the Speaker display. (Beo4: Press **LIST** and use the navigation button up or down to bring up **SPEAKER** in the Beo4 display).
- > Press **Optimise** if you want to optimise the sound, or press **Mode 1 – 5** to select the speaker combination you want. (Beo4: Press the **centre** button or 1 – 5). The selected speakers cut in automatically.
- > Press  to remove the Speaker display and return to the source you were using. (Beo4: Press and hold **BACK** to remove the **SPEAKER** from the Beo4 display).

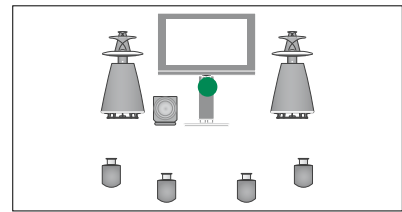

Mode 1

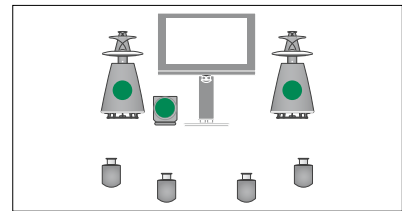

Mode 2

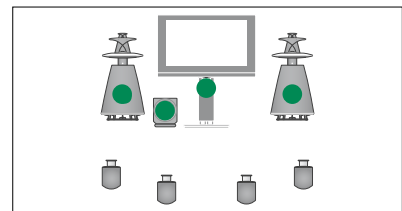

Mode 3

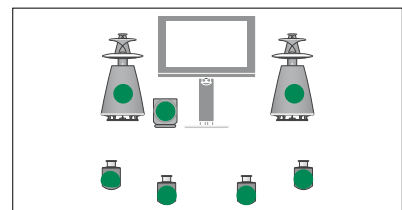

Mode 4

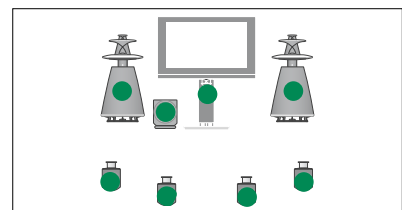

Mode 5

See two sources at the same time

Your remote control gives you access to a dual-screen function for viewing two video sources at the same time. You can also bring up a video source and an audio source at the same time. For example, you can view a video playback and a TV programme at the same time, provided that the selected sources are available in your system.

While watching a programme or recording, you can divide the screen between the current programme or recording and a new programme or recording. You can also swap the two pictures at any time.

You cannot watch two recordings at the same time.

If you watch 3D and switch on the dual-screen function, the television will switch to 2D.

If you have a Beo4, press LIST and use the navigation button up or down until P-V.AUX is shown in the Beo4 display, to view a source registered in the CONNECTIONS menu as V.AUX, such as a set-top box.

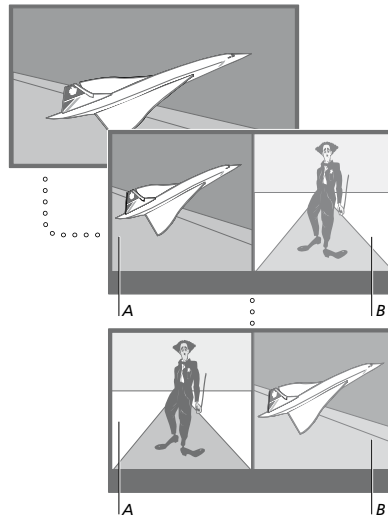

Volume adjustment always affects picture A, while other operations, such as selecting channels, affect picture B. Choosing a new source cancels dual-screen viewing.

You can view two HDMI (High Definition Multimedia Interface) sources at the same time, but only if one of the sources is connected to either the HDMI A or HDMI B socket, and the other source is connected to either the HDMI C or HDMI D socket. For further information about the HDMI sockets, see the chapter about connection panels in Getting Started.

While watching, for example, TV ...

- > Press **P-and-P** to bring up the P-and-P display on Beo6. (Beo4: Press **LIST** and use the navigation button up or down to bring up **P-AND-P**).
- > Press, for example, **DVD** to select the source to view on the right side of the screen (**B**).
- > Press **Swap** to swap the left picture and right picture. (Beo4: Press **0**).

To leave the dual-screen function ...

- > Press **BACK** to leave the function and return to normal viewing of the source on the left side of the screen (**A**) or simply select a source.

Pressing Text while the function is active brings up teletext on the right hand side of the screen for the source shown in picture B. If there is no teletext service available for this source, the screen turns black.

*To bring up V.TUNER on the right hand side of the screen, you must press **P-and-P**, then **TV**. (Beo4: Press **LIST** and use the navigation button up or down to bring up **P-AND-P**, then press **TV**). To bring up hard disk recordings on the right hand side of the screen, you must press **P-and-P**, then **V.MEM**. (Beo4: Press **LIST** and use the navigation button up or down to bring up **P-AND-P**, then press **V.MEM**).*

Home cinema

If you connect a projector, you can turn your television into a Home cinema. When you switch to the Home cinema setup, the television switches the picture from its own screen to the projector screen and activates the appropriate speakers.

Switch to Home cinema

If a projector is connected, you can use your remote control and move the picture from the television screen onto a projector screen for a special occasion or movie.

- > Press **⏮** to bring up the Scene display on Beo6, then press **Cinema** to bring up the Cinema display on Beo6. (Beo4: Press **LIST** and use the navigation button up or down to bring up **FORMAT**).
- > Press **Cinema** to switch between Home cinema mode and ordinary TV mode. (Beo4: Press **0**).
- > Press **⏮** to leave the function. (Beo4: Press **BACK**).

Set the television to switch itself on or off

Your television has a built in Sleep Timer which means that you can make it switch off after a designated number of minutes.

You can also make your television switch itself on and off automatically via the timed play and timed standby functions, for example, if there is a programme you do not want to miss.

Enter as many as six Timer settings, and bring up an on-screen list of the Timer settings you have entered. From this list, you can edit or delete your Timer settings.

If your television is integrated with a Bang & Olufsen audio or video system with a Master Link cable, these systems can perform the timed play or timed standby functions as well.

For your timed settings to be executed correctly, ensure that the built-in clock is set to the correct time. For further information, [see page 45](#).

NOTE! For safety reasons, the stand will not turn if the television is switched on by a PLAY TIMER.

Sleep Timer

You can make the television switch off automatically after a number of minutes.

To activate the Sleep Timer with Beo6 ...

- > Press **Sleep** repeatedly to select the number of minutes or **Off**.

*To activate the Sleep Timer with Beo4*¹ ...*

- > Press **LIST** and use the navigation button up or down to bring up **SLEEP** in the Beo4 display.
- > Press the **centre** button repeatedly to select the number of minutes.

To deactivate the Sleep Timer ...

- > Press **LIST** and use the navigation button up or down to bring up **SLEEP** in the Beo4 display.
- > Press the **centre** button repeatedly until **OFF** is shown in the television display.

To set the Sleep Timer via the menu ...

- > Bring up the TV SETUP menu and highlight **SLEEP TIMER**.
- > Press the **centre** button to bring up the **SLEEP TIMER** menu.
- > Press the **centre** button repeatedly to switch between the number of minutes and **OFF**.

¹* *If you have a Beo4 without navigation button, SLEEP may not be available.*

Play Timer

If you connect a Bang & Olufsen audio or video product to your television with a Master Link cable, you can exclude or include it in timed functions via the **PLAY TIMER** menu. For example, set the television **PLAY TIMER** to **ON** and an audio system's **PLAY TIMER** to **OFF** if you wish timed functions to apply only to the television.

To switch on the Play Timer ...

- > Bring up the TV SETUP menu and highlight **PLAY TIMER**.
- > Press the **centre** button to bring up the **PLAY TIMER** menu, and highlight **TIMER ON/OFF**.
- > Press the **centre** button to bring up the **TIMER ON/OFF** menu.
- > Use the navigation button left or right to reveal **ON**.
- > Press the **centre** button to store the setting.

For further information about how to program Timers and switch the Play Timer on or off for a connected Bang & Olufsen audio or video product, see the guide enclosed with the product.

Timed play and timed standby

You can preset your television to start and stop automatically at the same time and day every week.

To enter settings for timed play or timed standby ...

- > Bring up the TV SETUP menu and highlight PLAY TIMER.
- > Press the **centre** button to bring up the PLAY TIMER menu and highlight PLAY TIMER PROGRAMMING.
- > Press the **centre** button to bring up the PLAY TIMER PROGRAMMING menu.
- > Use the navigation button up or down to move through the menu items.
- > Enter information or use the navigation button left or right to view your choices for each item. When DAYS is highlighted, use the navigation button right once to be able to move through the days, and use the navigation button up or down to remove a day you do not want. Use the navigation button right to move to the next day, and use the navigation button left to move back to a previous day. When the weekday(s) you want are displayed, press the **centre** button to accept the day(s).
- > When you have filled in the required information, press the **centre** button to store your Timer settings.
- > Press **BACK** to back up through previous menus or press and hold **BACK** to exit all menus.

If the television is set up in a link room, Timer programming must be carried out on your main room television.

View, edit or delete a Timer

Bring up an on-screen list of the settings you have entered. From this list, you can edit or delete your Timer settings.

To view, edit or delete your Timer settings ...

- > Bring up the TV SETUP menu and highlight PLAY TIMER.
- > Press the **centre** button to bring up the PLAY TIMER menu and highlight PLAY TIMER INDEX.
- > Press the **centre** button to bring up your list of Timer settings. The first Timer setting in the list is already highlighted.
- > Use the navigation button up or down to move the cursor to a Timer setting you wish to edit.
- > To edit a setting, press the **centre** button and follow the procedure described under 'Timed play and timed standby'.
- > To be able to delete a selected setting, press the **yellow** button.
- > If you change your mind, use the navigation button left to move the setting back into the list. You can also press and hold **BACK** to exit all menus.
- > Press the **yellow** button a second time to delete the setting.

TIMER PROGRAMMING	
SOURCE	TV
GROUP	
CHANNEL	18 BBC
START TIME	15:40
STOP TIME	16:40
DAYS	M . . T F . S

PLAY TIMER PROGRAMMING menu

Abbreviations for days of the week:

M ...	Monday
T ...	Tuesday
W ...	Wednesday
T ...	Thursday
F ...	Friday
S ...	Saturday
S ...	Sunday

If a Wake-up Timer has been programmed, the television cannot be part of an ordinary PLAY TIMER or Standby Timer until the Wake-up Timer has been carried out or disabled.

>> Set the television to switch itself on or off

Standby settings

The television can be set to switch itself to standby after some time with no operation. The factory setting is 4 hours. This function only applies in video mode not in audio mode.

To make standby settings ...

- > Bring up the TV SETUP menu and highlight OPTIONS.
- > Press the **centre** button to bring up the OPTIONS menu and highlight STANDBY SETTINGS.
- > Press the **centre** button to bring up the STANDBY SETTINGS menu and use the navigation button up or down to move between AUTO STANDBY and POWER SAVING.
- > Use the navigation button left or right to select the setting you want.
- > Press the **centre** button to store the setting.
- > Press **BACK** to back up through previous menus or press and hold **BACK** to exit all menus.

When AUTO STANDBY is activated, a message appears on your television screen if the television has not been operated during the time set in the menu. The television then switches to standby, if you do not operate it.

STANDBY SETTINGS

AUTO STANDBY POWER SAVING	4 HOURS OFF
------------------------------	----------------

STANDBY SETTINGS menu.

When no signal has been detected for 15 minutes, the television is switched to standby.

If you set the POWER SAVING to ON, you cannot activate the television or its sources from your link room, while the main room television is in standby. Furthermore, when POWER SAVING is set to ON you cannot activate external PLAY TIMERS. In addition, there is no light in the standby indicator when the television is in standby.

Wake-up Timer

You can make the television wake you up in the morning.

The Wake-up Timer is a once-only Timer, it lasts for one hour. Like an alarm clock it is disabled once it has been executed. It applies only to the television it has been programmed on.

Once you have made one Wake-up Timer, the television automatically suggests the time you entered for the latest Wake-up Timer when you enter a new one.

Wake-up Timers can of course also be disabled again.

When you have programmed a Wake-up Timer, the television cannot be part of an ordinary PLAY TIMER until the Wake-up Timer has been carried out or disabled.

Enter a Wake-up Timer

You must choose the source and channel number of your Wake-up Timer as well as the start time.

To enter settings for a Wake-up Timer ...

- > Bring up the TV SETUP menu and highlight PLAY TIMER.
- > Press the **centre** button to bring up the PLAY TIMER menu and highlight WAKE UP TIMER.
- > Press the **centre** button to bring up the WAKE UP TIMER menu.
- > Use the navigation button up or down to move through the menu items.
- > Enter information or use the navigation button left or right to view your choices for each item.
- > When you have filled in the required information, press the **centre** button to store your Wake-up Timer.
- > Press **BACK** to back up through previous menus or press and hold **BACK** to exit all menus.



WAKE UP TIMER menu

Check or delete a Wake-up Timer

You can bring up the settings for the Wake-up Timer to check the time or to disable the Wake-up Timer by setting it to OFF.

To change settings for a Wake-up Timer or delete it ...

- > Bring up the TV SETUP menu and highlight PLAY TIMER.
- > Press the **centre** button to bring up the PLAY TIMER menu and highlight WAKE UP TIMER.
- > Press the **centre** button to bring up the WAKE UP TIMER menu.
- > Use the navigation button up or down to move through the menu items.
- > Use the navigation button left or right to change settings, or enter a new time. Change the ON/OFF setting to OFF if you wish to delete the Wake-up Timer.
- > When you have made your changes, press the **centre** button to store them.
- > Press **BACK** to back up through previous menus or press and hold **BACK** to exit all menus.

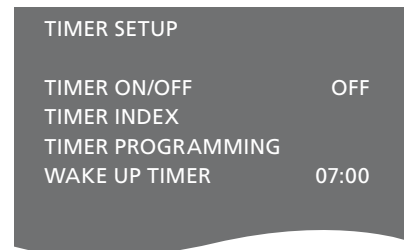

TIMER SETUP menu.

Set the time and date

When you preset your television to switch itself on or off at a particular time, or when you preset a timed recording of a programme on a connected Bang & Olufsen recorder, the clock ensures that these features are switched on and off at the right times.

The simplest way to set the clock is to synchronise it with a tuned TV channel's teletext service via the CLOCK menu. If you choose to synchronise the clock, this is done with the teletext service offered by the TV channel you are currently watching. If a teletext service is not available, you can set the clock manually.

Before synchronising the clock with a tuned channel, make sure that the channel you are watching offers a teletext service within your time zone.

- > Bring up the TV SETUP menu and highlight OPTIONS.
- > Press the **centre** button to bring up the OPTIONS menu and highlight CLOCK.
- > Press the **centre** button to bring up the CLOCK menu.
- > Use the navigation button up or down to move through menu items.
- > Use the navigation button left or right to see your choices for each item. It is only necessary to enter the time manually if SYNCHRONISE is set to NO.
- > Press the **centre** button to store your clock and calendar options, or ...
- > ... press and hold **BACK** to exit all menus without storing.

If the clock is not updated in the transition of daylight saving time, simply select the channel with which you originally synchronised the clock, and the clock is updated.

*If you have the optional DVB module, you can synchronise the clock with the module by selecting DTV as source. Then press **Menu** twice to bring up the TV SETUP menu for the module and follow the procedure described above.*

CLOCK	
TIME	20:00
DATE	23
MONTH	APR
YEAR	2009
SYNCHRONISE	NO

*To bring up the clock on the display, press **Clock** on Beo6. The clock display disappears again after ten seconds. (Beo4: Press **LIST** and use the navigation button up or down to bring up **CLOCK** and press the **centre** button).*

Abbreviations for months

Jan ...	January
Feb ...	February
Mar ...	March
Apr ...	April
May ...	May
Jun ...	June
Jul ...	July
Aug ...	August
Sep ...	September
Oct ...	October
Nov ...	November
Dec ...	December

Settings and preferences for the Blu-ray player

The Blu-ray menus offer options for settings and adjustments. Here you find detailed information about the individual menus.

For an overview of the Blu-ray menu structure, [see page 4](#).

The Blu-ray player only supports playback of 12 cm discs.

If you play back a 3D Blu-ray disc, it is automatically shown in 3D.

Bring up the SETUP menu

> Press **DVD Setup** to bring up the DVD SETUP menu. (Beo4: Press **LIST** and use the navigation button up or down to bring up **SHIFT** then press **8**).

What's on the PLAYBACK STATUS menu ...

STANDARD ... Playback status and stop status will be displayed.

EXTENDED ... Playback status, stop status and automatic status, such as **BONUS VIEW** and angle, will be displayed, if available on the disc.

What's on the AUDIO FORMAT menu ...

STANDARD ... Decode all audio formats to PCM for up to 7.1 (seven sound channels and one channel for low-frequency sound). **STANDARD** audio format is recommended to be able to play all sound tracks.

RE-ENCODE ... Decode all audio formats to DTS for up to 5.1 (five sound channels and one channel for low-frequency sound).

BITSTREAM ... All audio formats are sent in its original format for up to 7.1 (seven sound channels and one channel for low-frequency sound). If this option is selected, sound for Picture in Picture and effect sound for Blu-ray disc menus are not available.

What's on the VIDEO FORMAT menu ...

24 HZ ON ... The signals are sent in format 1080p and 24 HZ. This is recommended.

24 HZ OFF ... The signals are sent in native format.

What's on the LANGUAGE menu ...

AUDIO ... Enter the menu and select the preferred audio language to be used.

SUBTITLE ... Enter the menu and select the preferred subtitle language to be used*.

DISC MENU ... Enter the menu and select the language to be used in disc menus.

What's on the ACCESS CONTROL menu ...

When you enter the **ACCESS CONTROL** menu, you are asked to enter and confirm your access code. The first time you enter the menu, you are asked to select a new access code.

PARENTAL LOCK ... Enable or disable the Parental Lock function.

RATING ... Some discs feature a Parental Lock level. If you specify a level lower than the one contained on the disc, the disc will not play unless your access code is entered.

NEW ACCESS CODE ... Enter and confirm a new access code at any time.

What's on the ADVANCED menu ...

MEMORY MANAGEMENT ... You can reset the BD-Live memory in the **MEMORY SIZE** menu.

In the **MEMORY SETTING** menu, you can choose between **INTERNAL MEMORY** and **EXTERNAL USB**. If you want to use **BD-Live** you must insert a USB device in the USB port and select **EXTERNAL USB**. The USB port is placed in the AV6 socket group, see **Getting Started** for further information. The **BD-Live** content is stored on the USB device.

NETWORK ... If you choose the **CONFIGURATION** field to be **MANUAL** the fields **IP ADDRESS**, **SUBNET MASK**, **GATEWAY** and **DNS** become available.

The **MAC ADDRESS** field informs you of the Mac address.

MODULE INFORMATION ... See information about software version and regions.

SOFTWARE UPDATE ... If your television is connected to the Internet, you can update the Blu-ray player, provided that new software is available. For further information contact your retailer.

**Some discs will require you to choose a subtitle language from a disc menu, even if you have previously selected a default subtitle language from the LANGUAGE menu.*

To disable the Parental Lock ...

IMPORTANT! You can disable the Parental Lock completely if, for example, you have forgotten your access code. You must remove the disc from the Blu-ray player and make sure the loader is closed before you disable the Parental Lock.

- > Press **DVD** to activate the Blu-ray player.
- > Press **Menu** twice to bring up the TV SETUP menu. (Beo4: Press **MENU** twice).
- > Use the navigation button down to move the cursor down to the OPTIONS menu.
- > Press **Menu** to reveal the item PARENTAL LOCK. (Beo4: Press **MENU**).
- > Press the **centre** button to bring up the PARENTAL LOCK menu.
- > Press the **centre** button to disable the Parental Lock, or ...
- > ... Press and hold **BACK** to exit all menus without storing.

NOTE! When you disable the Parental Lock, the Blu-ray player restarts automatically. All settings you have made for the Blu-ray player, such as language selection, are reset and you must make your settings again.

Blu-ray player – media browser

You can play music and browse your photos stored on a USB device or data disc on your television. You get access to the MEDIA BROWSER menu, when you insert a data disc or USB device in your television.

If you have music and photos stored on the same data disc or USB device, you can start the music and return to the main menu to start a slide show of your photos. Then you can play music and see your photos at the same time.

The Blu-ray player only supports playback of music files in MP3 format and photo files in JPEG format.

Only remove a USB device when the Blu-ray player is switched off.

To play content from the USB device, playback of a loaded disc must be stopped.

Use the media browser

During playback of your music, you can see the NOW PLAYING menu with cover, and information about artist, title and track, if available. When you browse your photos you can bring up the INFO menu and get access to additional functions.

Listen to your music ...

- > Press **DVD** to activate the Blu-ray player.
- > Insert a data disc or USB device with your music.
- > Use the navigation button up or down to select DATA DISC or USB and press the **centre** button.
- > Use the navigation button up or down to select the MUSIC menu and press the **centre** button.
- > Use the navigation button up or down to browse your files and folders and press the **centre** button to open the folder or start playback of the file.
- > Use **◀** and **▶** to cue during playback.
- > Use **▲** and **▼** to step in tracks during playback.
- > Press **STOP** to pause.
- > Press **Repeat** to repeat playback (Beo4: press the **yellow** button then press 6).
- > Press **PLAY** to resume playback.
- > Press **BACK** to back up through previous menus or press and hold **BACK** to return to the main menu.

MEDIA BROWSER

PHOTO
MUSIC

MEDIA BROWSER menu.

Browse your photos...

- > Press **DVD** to activate the Blu-ray player.
- > Insert a data disc or USB device with your photos.
- > Use the navigation button up or down to select DATA DISC or USB and press the **centre** button.
- > Use the navigation button up or down to select the PHOTO menu and press the **centre** button.
- > Use the navigation button up or down to browse your files and folders and press the **centre** button to open the folder.
- > Press the **centre** button to open your photo in full screen view. The slideshow starts automatically.
- > Press **STOP** to pause.
- > Press **PLAY** to resume playback.
- > Press **BACK** to back up through previous menus or press and hold **BACK** to return to the main menu.

The pincode system

The pincode system is intended to make normal use of your television impossible for someone who does not know the pincode. You choose whether or not to activate the pincode system.

When the pincode system is activated and the television has been disconnected from the mains for 15–30 minutes, the pincode system goes into effect.

When reconnected and switched on, the television automatically switches itself off after four minutes. Entering the pincode returns the television to normal.

Note: If you change your pincode more than five times within a three-hour period, the PINCODE menu becomes inaccessible for three hours, assuming that the television is not disconnected from the mains. Disconnecting the television resets the three-hour period.

Activate the pincode system

If you wish to deactivate the pincode system, you can do so by deleting your pincode.

To activate the pincode system ...

- > Bring up the TV SETUP menu.
- > Press **◀** twice, followed by **STOP**. The PINCODE menu appears on the screen.
- > Enter the four digits of your code.
- > Press the **centre** button after the last digit is found.
- > Re-enter your code to confirm it and press the **centre** button again. If the two codes are not identical, the input fields are cleared and you must enter the code again.

To change or delete your pincode ...

- > Bring up the TV SETUP menu.
- > Press **◀** twice, followed by **STOP**. The PINCODE menu appears on the screen.
- > Enter the correct pincode and press the **centre** button. DELETE PINCODE is highlighted.
- > To delete your code, press the **centre** button.
- > To change your code, use the navigation button down to highlight NEW PINCODE and press the **centre** button. Enter the new code and press the **centre** button. Re-enter the new code to confirm it.

*If you inadvertently press a wrong button while entering a code, press **BACK**. The entry is cancelled and the input fields are cleared.*

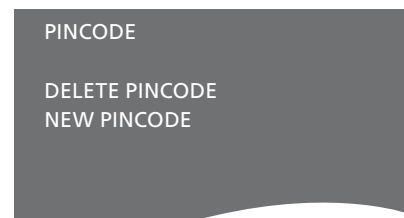
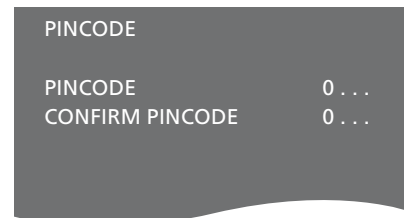

Enter the pincode

If your television has been disconnected from the mains for 15–30 minutes, the television prompts you for the pincode when you switch it on. You may not be able to switch the television on immediately – wait approximately 30 seconds and try again.

IMPORTANT! *If you are prompted for a pincode the first time you switch on your television, contact your Bang & Olufsen retailer.*

Should you lose or forget your code, contact your Bang & Olufsen retailer. Your retailer can provide you with a mastercode, which disables your pincode.

To enter your pincode ...

- > Enter the code digits.
- > Press the **centre** button when the last digit is entered.
- > Your television starts up again.

Five incorrect entries will cause the television to shut down for three hours, during which operation is not possible.

If you have forgotten your pincode ...

- > Contact a Bang & Olufsen retailer to receive a five-digit mastercode.
- > When the television prompts you for your pincode, press and hold ◀◀ to bring up the MASTERCODE menu.
- > Enter the code digits and press the **centre** button to deactivate your pincode and reactivate your television.

To use the pincode system again ...

- > Follow the procedure for activating the pincode system.

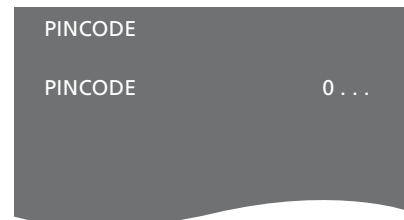

Set up your remote control

You must set up your television to be operated with a remote control with or without a navigation button.

Even though your remote control has a navigation button, you can choose to set your television up for operation without navigation button. This can be useful if you have a BeoLink system also comprising a television without the REMOTE CONTROL menu.

If you set up your television for operation without a navigation button and your Beo4 has a navigation button, you must also change the MODE setting of your Beo4. See the Beo4 Guide or contact your retailer for further information.

Remote control settings

In the REMOTE CONTROL menu you set up whether the remote control you are using has a navigation button or not.

To make remote control settings ...

- > Bring up the TV SETUP menu and highlight OPTIONS.
- > Press the **centre** button to bring up the OPTIONS menu, and highlight REMOTE CONTROL.
- > Press the **centre** button to bring up the REMOTE CONTROL menu.
- > Use the navigation button up and down to highlight the setting you want.
- > Press the **centre** button to store the setting.
- > Press **BACK** to back up through previous menus or press and hold **BACK** to exit all menus.

REMOTE CONTROL

NAVIGATION BUTTON

NO NAVIGATION BUTTON

For information about menu operation with the different types of remote controls, [see page 5](#).

Feature activation

Additional features in your television can be made accessible via the FEATURE ACTIVATION menu. For information about additional features, contact your Bang & Olufsen retailer.

Feature activation key

In order for additional features to become available, a feature activation key must be entered. The feature key can be purchased from your Bang & Olufsen retailer. The key cannot be deactivated again.

To enter an activation key ...

- > Bring up the TV SETUP menu and highlight OPTIONS.
- > Press the **centre** button to bring up the OPTIONS menu and highlight FEATURE ACTIVATION.
- > Press the **centre** button to bring up the FEATURE ACTIVATION menu.
- > Select the feature, you wish to activate and press the **centre** button.
- > Enter the 12 digit key. An incorrect number can be deleted by pressing the navigation button left, all numbers can be deleted by pressing **BACK**.
- > When the numbers are entered, press the **centre** button to accept.



HDMI Matrix

The HDMI Matrix feature is an additional feature which can be purchased separately. When the purchased feature activation key is entered, additional software becomes available in your television. The HDMI Matrix itself is a physical product that can be connected allowing you to connect several external sources to your television and access them via the Beo6 remote control. For information about additional features, contact your Bang & Olufsen retailer.

Important information

The HDMI Matrix must be connected and set up by your Bang & Olufsen retailer.

- Your Beo6 remote control must be reconfigured before you can use the HDMI Matrix.
- You cannot operate the HDMI Matrix with a Beo4 remote control.
- You cannot connect more than one HDMI Matrix in a setup.
- The HDMI Matrix cannot be configured on an HDMI Expander.
- You cannot configure both the HDMI Matrix and a source centre.

Settings in the HDMI MATRIX menu ...

In the HDMI MATRIX menu, you can select settings for your HDMI Matrix.

In the CONNECTIONS menu ...

- > Select the socket group to which you have connected a HDMI Matrix.
- > Select the HDMI MATRIX field and set it to YES.
- > The field INPUTS appears and you can specify the number of sources you want to connect. Set the field to a higher number of sources than you have connected.
- > Select an HDMI socket. You cannot select NONE.
- > Press the **centre** button to store the settings and bring up the HDMI MATRIX menu.
- > Select the connected HDMI Matrix type.
- > Press the **centre** button to store the settings and bring up the CONTROL menu.
- > Select an IR type to indicate how the TV control is connected to the HDMI Matrix.
- > Press the **centre** button to store the settings.

When you have stored the settings for the HDMI Matrix, an input list menu appears for you to configure the sources connected to the matrix, [see page 54](#).

AV1	
SOURCE	V.AUX2
HDMI MATRIX	YES
INPUTS	8
AUTO SELECTION	NO
TIMER RECORDER	NO
HDMI	A
SOUND INPUT	HDMI

If you at a later time disable a stored HDMI Matrix configuration by setting the HDMI MATRIX field to NO, your settings are still saved. This means that if you set the field to YES later, all your settings reappear.

When a HDMI Matrix is activated, it is automatically registered as V.AUX2, also if another source may already be registered as V.AUX2. This source must then be registered to another source name.

Add sources to your setup ...

The sources connected to the HDMI Matrix must be registered in the television.

Configuration of inputs ...

- > Configure each input one by one.
- > Name each input by following on-screen instructions. If you do not name an input, the name from the selected PUC list is used.
- > Select a PUC source for the specific input. The sources are divided into four categories: SET-TOP BOX, DVD PLAYER/RECORDER, VIDEO RECORDER and OTHER.
- > When you store the input settings, you can configure the next input. Continue the procedure until all connected inputs are configured.
- > Press the **green** button to return to the CONNECTIONS menu.

HDMI MATRIX	
INPUT 1	NONE
INPUT 2	NONE
INPUT 3	NONE
INPUT 4	NONE
INPUT 5	NONE
INPUT 6	NONE
INPUT 7	NONE
INPUT 8	NONE

Teletext

Daily use of teletext is described in Getting Started, however, you can also store favourite teletext pages for quick reference.

Store favourite teletext pages

Nine MEMO pages are available for each television channel's teletext service.

To create a MEMO page ...

- > Bring up a page you view often.
- > Use the navigation button left or right to move the cursor along the menu bar to SETUP and press the **centre** button. The 9 available MEMO slots are shown by number. The first is highlighted.
- > Press the **centre** button to store the current page. The cursor moves to the next available MEMO slot.
- > Use the number buttons on your remote control to select the next teletext page you wish to store.
- > Repeat the procedure for each page you wish to store.
- > To leave the MEMO setup, move the cursor to BACK on the teletext menu bar and press the **centre** button.
- > Press **BACK** to leave teletext.

Day-to-day use of MEMO pages

You may wish to refer to your teletext MEMO pages quickly, for example, if you are leaving for work and wish to check traffic information on a teletext service.

To view MEMO pages ...

- > Press **Text** to bring up teletext.
- > Press **◀** or **▶** to move between MEMO pages.
- > Press **BACK** to leave teletext.

To delete a MEMO page ...

- > Use the navigation button left or right to move the cursor to SETUP and press the **centre** button.
- > Move the cursor to the MEMO page you wish to delete and press the **yellow** button.
- > Press the **yellow** button again to confirm.

To view teletext subtitles for a programme ...

If you want available teletext subtitles to appear automatically for a particular programme, store the teletext subtitles page as MEMO page 9.

When you choose a DVB channel, you must bring up and leave teletext to activate the subtitles, and if you have stored other MEMO pages the teletext subtitles page should be stored as MEMO page 1.

If your TV is linked via a Master Link cable to another TV, stored MEMO pages are not shared among these TVs. MEMO pages must be stored manually on each linked TV.

Operate other equipment with Beo6 or Beo4

The built-in Peripheral Unit Controller acts as an interpreter between connected video equipment, such as a set-top box, video recorder or DVD player, and your Bang & Olufsen remote control.

Use the Bang & Olufsen remote control to gain access to the functions offered by your non-Bang & Olufsen equipment.

When you switch on the equipment, the functions are available via the Beo6 display, or via a menu-overlay on the television screen, if you use a Beo4 remote control.

For instruction in the various functions offered by your equipment, see the product's own guide.

Some features and functions of the television may not be available when non-Bang & Olufsen equipment is connected. Not all connected video equipment are supported by Bang & Olufsen. For further information about supported equipment, contact your Bang & Olufsen retailer.

Use the Beo6 remote control

The main functions of your equipment can be operated with the Beo6 remote control. Not all functions may be supported by Beo6. The available services and functions are shown in the Beo6 display when you activate the equipment.

- > Press a source button, for example **DTV**, to switch on connected equipment.
- > Press the button on the Beo6 display that activates the function you want.

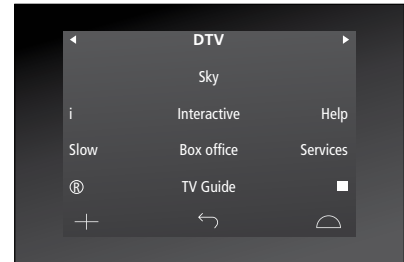

Example of a Beo6 display used to operate a set-top box.

Use equipment menus

Once you have activated connected equipment, you can operate its own menus with your remote control.

While equipment menus are shown ...

- > Use the navigation button up, down, left and right to move in menus.
- > Press the **centre** button to select and activate a function.
- > Press **BACK** to exit menus, or return to a previous menu.
- > Press **+** and use the number buttons to enter information in menus or services when relevant. (Beo4: Use the number buttons).
- > Use the coloured buttons as indicated in the menus of your connected equipment.
- > Press **BACK** to back up through previous menus or press and hold **BACK** to exit all menus.

*When you have selected connected equipment as a source, press **Menu** twice to bring up the television's main menu.*

Use the Beo4 remote control

If you have a Beo4 remote control, some functions are available directly via Beo4 when you switch on the equipment. Additional functions are available through a menu-overlay that you bring up on the screen. In this menu you can see which Beo4 buttons activate specific services or functions.

Your Bang & Olufsen retailer can provide you with a 'show mapping' survey which explains operation of the connected equipment with Beo4 in more detail.

- > Press a source button, for example **V.MEM**, to switch on connected equipment.
- > Press **MENU** to bring up the menu-overlay.
- > Press the number button that activates the function you want, or press one of the coloured buttons to activate a function.

*The menu-overlay for equipment connected to a main room television cannot be displayed on the television screen in the link room. However, you can still access the different features if you press **LIST** and use the navigation button up or down to bring up **SHIFT** and then select a number or colour.*

Direct Beo4 operation

If you know which Beo4 button activates the function you want, you can activate the function without bringing up the menu-overlay first.

While your equipment is on ...

- > Press one of the coloured buttons to activate a function.
- > Press and hold the **centre** button to bring up the Program Guide or the 'Now/Next' banner on the screen if you are using equipment that supports these functions.
- > Press **MENU** and use the number buttons to activate the function you want.
- > Use **▲** and **▼** to step between channels*.
- > Use **◀** and **▶** to rewind and wind in, for example, recordings*.

**This operation does not apply to Beo4 without navigation button.*

*On some connected equipment you have to press **LIST** and use the navigation button up or down to bring up **SHIFT** and press **9** to switch the equipment on and off, and on some you have to press **PLAY** then **0**.*

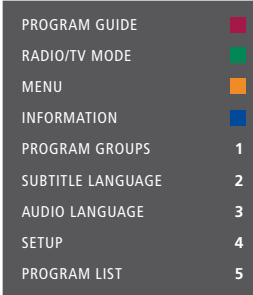

PROGRAM GUIDE	■
RADIO/TV MODE	■
MENU	■
INFORMATION	■
PROGRAM GROUPS	1
SUBTITLE LANGUAGE	2
AUDIO LANGUAGE	3
SETUP	4
PROGRAM LIST	5

Example of a menu-overlay. The Beo4 buttons are shown to the right on the menu, and the functions they control are shown to the left. The menu may also list buttons on the remote control included with your connected equipment.

Connect and operate an audio system

If you connect a compatible Bang & Olufsen audio system to the television using a Master Link cable, you obtain the benefits of an integrated audio/video system.

Play a CD on your audio system using speakers connected to the television, or switch on a TV programme and send the sound to your audio system speakers.

Your AV system can be placed together in one room or in two rooms with the television placed in one room and the audio system with a set of speakers placed in another.

If you want to use Master Link to integrate your audio/video system, you must set POWER SAVING to OFF, [see page 42.](#)

Not all Bang & Olufsen audio systems support integration with the television.

Connect your audio system to the television

Using a BeoLink cable, connect the sockets marked MASTER LINK on the television and the audio system.

Program the AV setup with Beo6

If your television has been set up in an AV system, you may need to set it to the correct Option with Beo6. Switch the entire system to standby first.

Option setting for the television ...

- > Place yourself in front of the television.
- > While holding the • button, press the **centre** button to bring up the Setup menu on Beo6.
- > Let go of both buttons.
- > Press **Option Pgm** to bring up the Option Programming display on Beo6.
- > Press the button that matches the zone in which the television is placed, for example, **Tv Area**.

Option setting for the audio system ...

- > Place yourself in front of the audio system.
- > While holding the • button, press the **centre** button to bring up the Setup menu on Beo6.
- > Let go of both buttons.
- > Press **Option Pgm** to bring up the Option Programming display on Beo6.
- > Press the button that matches the zone in which the audio system is placed, for example, **Audio Area**.

If you move your link room products to other rooms, remember to have your Beo6 remote control reconfigured by your Bang & Olufsen retailer.

Program the AV setup with Beo4

You can set your television, placed in an AV-system, to the correct Option using Beo4. Switch the entire system to standby first.

Option setting for the television ...

- > While holding the • button on Beo4, press **LIST**.
- > Let go of both buttons.
- > Use the navigation button up or down to bring up **OPTION?** in the Beo4 display and press the **centre** button.
- > Use the navigation button up or down to bring up **V.OPT** in the Beo4 display and then enter the appropriate number (**1, 2, 4, 5** or **6**).

Option setting for the audio system ...

- > While holding the • button on Beo4, press **LIST**.
- > Let go of both buttons.
- > Use the navigation button up or down to bring up **OPTION?** in the Beo4 display and press the **centre** button.
- > Use the navigation button up or down to bring up **A.OPT** in the Beo4 display and enter the appropriate number (**0, 1, 2, 4, 5** or **6**).

>> Connect and operate an audio system

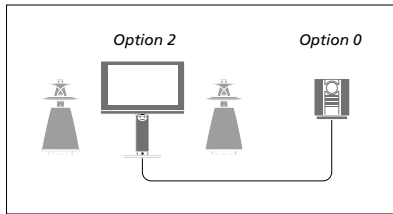

If the television and an audio system is set up in one room with all speakers connected to the television, set the television to Option 2 and the audio system to Option 0.

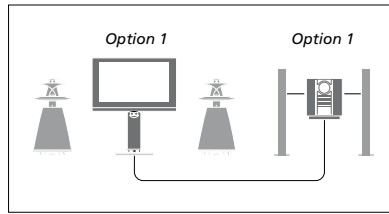

If the television (with or without additional speakers) and the audio system (with a connected set of speakers) is set up in the same room, set the television to Option 1 and the audio system to Option 1.

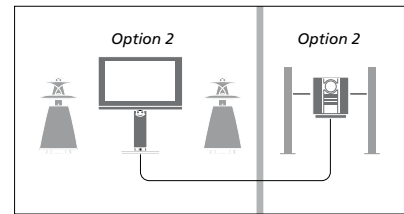

If the audio system is set up in one room, and the television (with or without additional speakers) in another, set the television to Option 2 and the audio system to Option 2.

For information about Option 4, 5 and 6, see [pages 63](#) and [65](#). For further information, contact your retailer.

Use an audio/video system

If you integrate your audio system and your television, you can choose a speaker combination appropriate to the current video or audio programme, and also record video sound on the audio system.

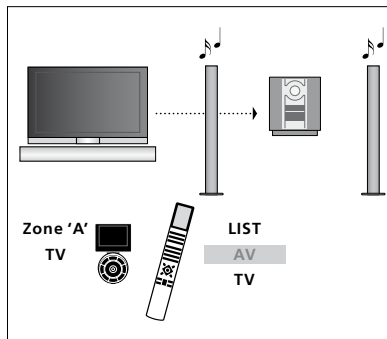

To listen to sound from a television source on your audio system speakers without switching on the screen, select the zone for your audio system speakers on Beo6, and then press a source button, such as **TV**. (Beo4: Press **LIST** and use the navigation button up or down to bring up **AV** in the Beo4 display, then press **TV**). Beo6 instruction is shown to the left and Beo4 instruction to the right.

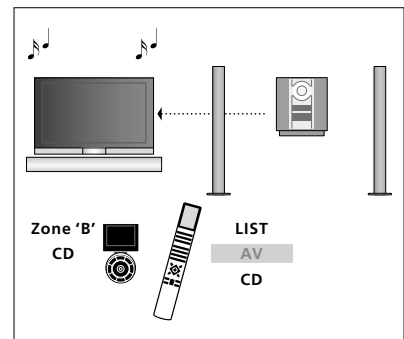

To listen to audio sound on the speakers connected to the television, select the zone for speakers connected to the television on Beo6, and then press an audio source button, such as **CD**. (Beo4: Press **LIST** and use the navigation button up or down to bring up **AV** in the Beo4 display, then press **CD**). Beo6 instruction is shown to the left and Beo4 instruction to the right.

Distribute sound and picture with BeoLink

The BeoLink system makes it possible to distribute picture and/or sound to other rooms throughout the house.

For example, you can connect your television in the living room to another video system or set of speakers in another room, thereby making it possible to 'move' the picture or sound to other rooms.

If you have a BeoLink distribution system installed, you can either use your television in the main room, such as a living room, or in a link room, such as a study or bedroom.

Under certain circumstances, it may be necessary to enter modulator settings.

Link connections

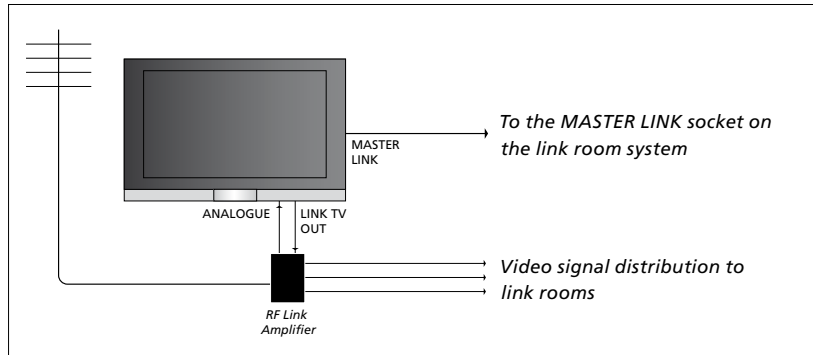

The main room television must be connected to the link room system with a Master Link cable:

- > Connect the Master Link cable to the socket marked MASTER LINK on the television.
- > If you want to distribute video signals as well, connect an ordinary aerial cable to the socket marked LINK TV on the television. Then run the aerial cable to the RF Link Amplifier and the Master Link cable to the link room. Follow the instructions enclosed with the link room equipment.

If an audio system is already connected to the Master Link socket and you wish to connect more equipment, the Master Link cable must be split in two and joined with the cable from the link room using a special junction box. Contact your Bang & Olufsen retailer for assistance.

HDMI, VGA and Y – Pb – Pr signals cannot be distributed from a main room television to the link room system.

If you set the POWER SAVING to ON, you cannot activate the television or its sources from your link room, while the main room television is in standby.

System modulator

If you have an audio setup, such as a BeoLink Active/Passive, and you choose to set up a non-linkable television in the same room, you must set the system modulator to ON. The factory setting is AUTO, which must be used if you are using a linkable Bang & Olufsen television.

To switch on the system modulator ...

- > Bring up the TV SETUP menu and highlight OPTIONS.
- > Press the **centre** button to bring up the OPTIONS menu and highlight CONNECTIONS.
- > Press the **centre** button to bring up the CONNECTIONS menu, and highlight LINK.
- > Press the **centre** button to bring up the LINK menu and highlight MODULATOR.
- > Use the navigation button left or right to reveal ON.
- > Press the **centre** button to store the setting, or ...
- > ... press and hold **BACK** to exit all menus without storing.

Link frequency

If, for example, a TV channel in your area is broadcasted on the same frequency as the factory setting for the BeoLink system; 599 MHz, you must tune the system modulator to an unoccupied frequency. When you change the link frequency in the main room television, make sure that the link frequency in the link room television corresponds to it.

To change the link frequency ...

- > Bring up the TV SETUP menu and highlight OPTIONS.
- > Press the **centre** button to bring up the OPTIONS menu and highlight CONNECTIONS.
- > Press the **centre** button to bring up the CONNECTIONS menu, and highlight LINK.
- > Press the **centre** button to bring up the LINK menu and highlight FREQUENCY.
- > Use the navigation button left or right to find an unused frequency.
- > Press the **centre** button to store the setting, or ...
- > ... press and hold **BACK** to exit all menus without storing.

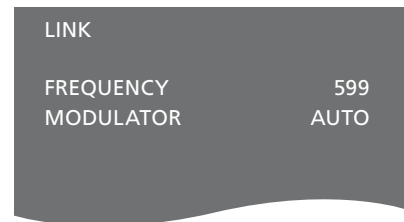

The LINK menu.

When tuning in the link frequency in the link room, a test image is shown. FINE TUNE is only available in link room/Option 4 setups.

Your television in a link room

If you have BeoLink installed in your home and you choose to place your television in a link room, you can operate all connected systems through the television.

You must follow the procedure described below when you connect your television for use in a link room:

- 1 **Connect the link room television to the mains**
- 2 **Using your remote control, program the link room television to the correct Option**
- 3 **Disconnect the link room television from the mains**
- 4 **Make the necessary connections**
- 5 **Reconnect the link room television to the mains.**

Option setting

For your entire system to function properly, it is essential that the television in the link room is set to the correct Option before you connect it to the television in the main room!

With Beo6 ...

- > Place yourself in front of the link room television.
- > While holding the **•** button, press the **centre** button to bring up the Setup menu on Beo6.
- > Let go of both buttons.
- > Press **Option Pgm** to bring up the Option Programming display on Beo6.
- > Press the button that matches the zone in which the television is placed.

With Beo4 ...

- > While holding the **•** button, press **LIST** on Beo4.
- > Let go of both buttons.
- > Use the navigation button up or down to bring up **OPTION?** in the Beo4 display and press the **centre** button.
- > Use the navigation button up or down to bring up **V.OPT** in the Beo4 display and press **6***.

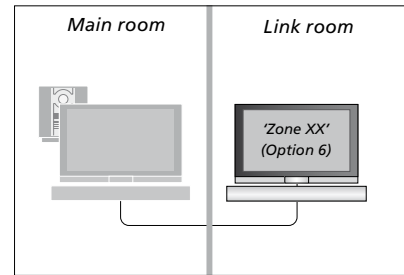

**If you connect the television for use in a link room where other link systems are already connected, such as speakers, you must set the television to Option 5 instead.*

Link room operation

When you are in the link room, you can operate all connected systems with the remote control.

Use sources present only in one of the rooms ...

- > Press the button for the source you wish to use, for example **RADIO**.
- > Operate the selected source as usual.

Use a main room source – source type present in both rooms ...

- > Press **Link** to bring up a source display. (Beo4: Press **LIST** and use the navigation button up or down to bring up **LINK** in the Beo4 display).
- > Press the button for the source you wish to use, for example **TV**.
- > Operate the source as usual.

Use a link room source – source type present in both rooms ...

- > Press the button for the source you wish to use, for example **TV**.
- > Operate the source as usual.

Listen to stereo sound in your link room ...

Usually sound distributed from a main room video source, such as a set-top box, to the link room is transmitted in mono. However, you can select stereo sound:

- > Press **TV** to switch on the television.
- > Press **AV** to bring up a source display. (Beo4: Press **LIST** and use the navigation button up or down to bring up **AV** in the Beo4 display).
- > Press, for example **DTV**, to activate a source connected to the main room television, such as a set-top box.

While using this function, distribution of other main room sources to other link room systems is not possible.

*Sound in the main room and the link room is sometimes not synchronised. In some cases, you can synchronise the sound by selecting a source, then pressing **AV** and selecting the source again. (Beo4: Select a source, then press **LIST** and use the navigation button up or down to bring up **AV** in the Beo4 display and then select the source again).*

If you switch to a different source in the main room, the sound volume may change.

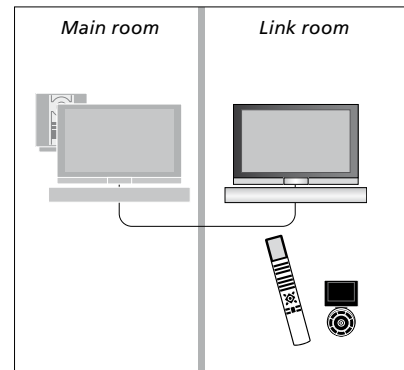

Two televisions in the same room

If you have placed your television in a room where you already have a Bang & Olufsen television, and commands from your remote control can be received by both televisions, you must change the Option setting of the television. This prevents simultaneous activation of both televisions.

When you Option program the television, disconnect the television you do not want to program from the mains. This ensures that only the television, you want to program, receives the Option programming.

One remote control for both televisions

For your television to function properly, it is essential that the television is set to the correct Option. If you have a Beo4, you must set your television to Option 4, and if you have a Beo6, you must set the television to the correct zone*.

Beo4 – Operate your television in Option 4 ...

Normally, you can activate a source, such as TV, simply by pressing the relevant source button on your remote control. However, when you set your television to Option 4, you must do the following, if you have a Beo4:

- > Press **LIST** and use the navigation button up or down to bring up **LINK** in the Beo4 display.
- > Press a source button, such as **TV**.

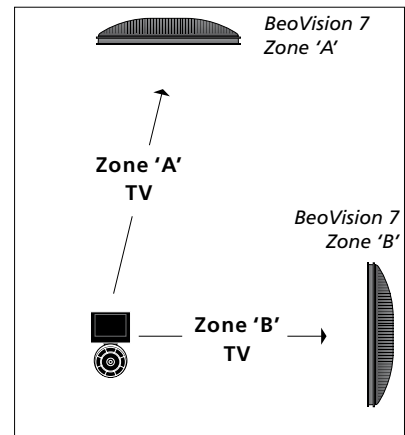

Beo6 operation.

**NOTE! For information about choice of zone, contact your Bang & Olufsen retailer.*

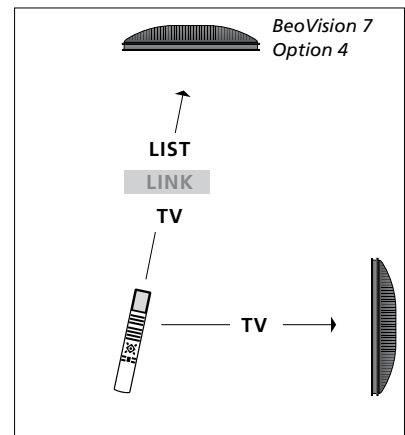

Beo4 operation.